

Fly Baby Sheet Steel Layouts

5/2/04

Ted Cannaday

Within this PDF file are full-size layout drawings for all the .063", .093" and 3/16" fittings for the Fly Baby as shown in Pete Bowers' plans book, along with one of the 1/4" parts. They are arranged to fit the standard available sheets in sizes 9" x 18" and 9" x 9", and 1 1/4" strips in the case of the 1/4" material. Since these sizes cannot be printed on commonly available printers, each layout sheet is divided up into two or three printed pages which should be 'assembled' before use. To this end, registration marks and dashed assembly lines are provided at the 6" and 12" points, along with rulers along two edges of each sheet and strip.

While I am officially not recommending that you use these drawings as cut templates, but only as part layout guides (since these are Pete's plans, not mine), my goal was and is to have the parts come out the correct size after printing. That's why I used PDF (Portable Document) format, which is supposed to be, well, Portable between any kind of printer. *While these may print out properly scaled on your computer's printer, some brands of printers don't scale them properly.* I and others have tried these printouts on several printers and they came out perfect. But there is no guarantee that this will be true in your case. You MUST compare the ruler marks printed out on each sheet, in both the vertical and horizontal directions, to a good-quality ruler. If they don't match, you'll need to do a simple calibration on your printer driver. See your printer documentation for the calibration procedure. (Note that one tester *did* need to do this calibration, and then the layouts printed correctly.)

PART NUMBERS

The drawings use a part number scheme suggested by Ron so that we'll all be on the same page when we are referring to a particular part. The number incorporates the figure number, then adds a dash number relative to a grid-type overlay on top of Pete's drawing, then a final clarifier if necessary (left/right, etc.).

	A	B	C	D	E	F	G
1							
2							
3							
4							
5							
6							
7							
8							
9							
10							

Use 1 inch spacing. Pete puts all his figures in a 7x10 box. You can print a sample grid on a transparency, or just use a ruler like I did (there aren't **that** many parts per page). Start with a single character representing the basic component:

W = wing

F = fuselage

T = tail

G = gear

M = misc parts

Then, the figure number (examples):

114 = figure 1-14

305 = figure 3-5

Then, the position on the page using the above grid (examples):

A1 = upper left

D5 = middle of the page

etc.

Then, any needed suffix:

L = left

R = right

I = inner

O = outer

Example: **W405-G8-L** = Wing, Figure 4-5, Page position G-8, Left side.

Sometimes the drawing will show "L/R" on one part (like this one), meaning that you bend one one way, and one the other to get the L and R parts.

GRAIN DIRECTION

I have specified the grain direction on the layouts, with the assumption that tensile strength will be higher along the grain direction. However, I AM NOT A STRUCTURAL ENGINEER so this is my own assumption, along with even the *desirability* of increased strength along a particular direction on a part. Note that this assumption sometimes includes parts like the aileron horn W405-D2 with the grain direction 'divided' evenly between each leg so one won't be stronger than the other. Also note that only one sheet (063-3) has grain *in the shorter direction*; all others are in the 18" direction. Wicks Aircraft offers the choice of grain direction in 9x18 sheets.

PART GAP

I used 3/16" gaps between parts to allow for use of one of those inexpensive 4 1/2" metal cutting bandsaws you can get at Harbor Freight or many other places, and then finish with a disc sander. Those bandsaws have a small table that works great if you're not in a production environment (which we're not). I thought that 1/8" might cause the builder to make one single cut between parts since there isn't enough material to do two cuts, and the end result would be a LOT of material needing to be removed with a sander or file.

PART THICKNESS RANGE

In some cases Pete specifies a range of thicknesses for a particular part, like ".063-.093". After hearing from the group I understand that folks want the thinner version to save weight, so where there was an option I arranged them that way.

BEND LINES

I used bend lines as shown by Pete. I know that, in a perfect world, things like bend allowance and sight lines would be taken into account, but the reality is that in most cases with these parts it is simply not that critical. Ron says that Pete already took the bend line issue into account with his drawings, so I'm leaving it at that.

MISSING PARTS

There is at least one part that is not included in these drawings:

G205-E8 Ldg Gear Wing Wire Anchor – This part will be sized based on the I.D. of your axle and the width of your wheel, therefore everyone's might be different.

PLANS MODIFICATIONS

There are a few cases where the consensus has been to modify a part from the original plans. I have generally included these modifications. They are:

W403-D2 Wing spar fittings – modified per Pete's correction on plans page 9-1

M606-SP1 Rudder horn reinforcement gussets – as shown on the bowersflybaby.com web site

G202-C6-B Ldg gear bracket – Lengthened as suggested by a group member at S'nF '04 for ease of connection to the LG brace wires. Since this is the only time I've heard of this mod, both versions (Pete's shorter one and the modified version) are shown using dashed lines.

OPTIONAL PARTS

There are some optional parts for strengthening where it's not worth the trouble to make layout sheets. These are the Spar Pin Reinforcement Strips described in section 9 of the plans. In this case, 1 ¼" x .063" 4130 steel strips are available in 3' lengths from Aircraft Spruce. Since the parts are 22" long you can make one part per 3' strip, avoiding such a long cut in a sheet. Of course, if you want to cut a larger sheet you can, but it's really not that much more expensive to use the pre-sheared strips.

MATERIALS LIST

I have laid out the parts on steel sheet sizes of 9" x 18" and 9" x 9", plus a 1¼" strip of .250. If you cut everything in these layouts you'll need the following materials:

- (3) .063 x 9" x 18" 4130N sheet
- (1) .063 x 9" x 9" 4130N sheet
- (6) .093 x 9" x 18" 4130N sheet
- (1) .093 x 9" x 9" 4130N sheet
- (1) .190 x 9" x 9" 4130N sheet
- (1) .250 x 1 ¼" x 18" 4130N strip

.093 vs .090 vs .100?

It has been suggested in the Fly Baby list that, since the .093 that Pete specifies is not available, everyone is going with .100 for steel for the fittings. This makes sense for the more critical fittings, however, I read in the Sept. 1967 Fly Baby Bulletin that Pete told a reader that all .093 may be replaced with .090, which IS available from both ACS and Wicks, and is both cheaper (at Wicks at least) and lighter by 10%, plus probably easier to bend. Mind you, this is just hearsay, but I mention it for those interested.

So, Happy Building! If you have any corrections or suggestions please let me know.
Ted Cannaday

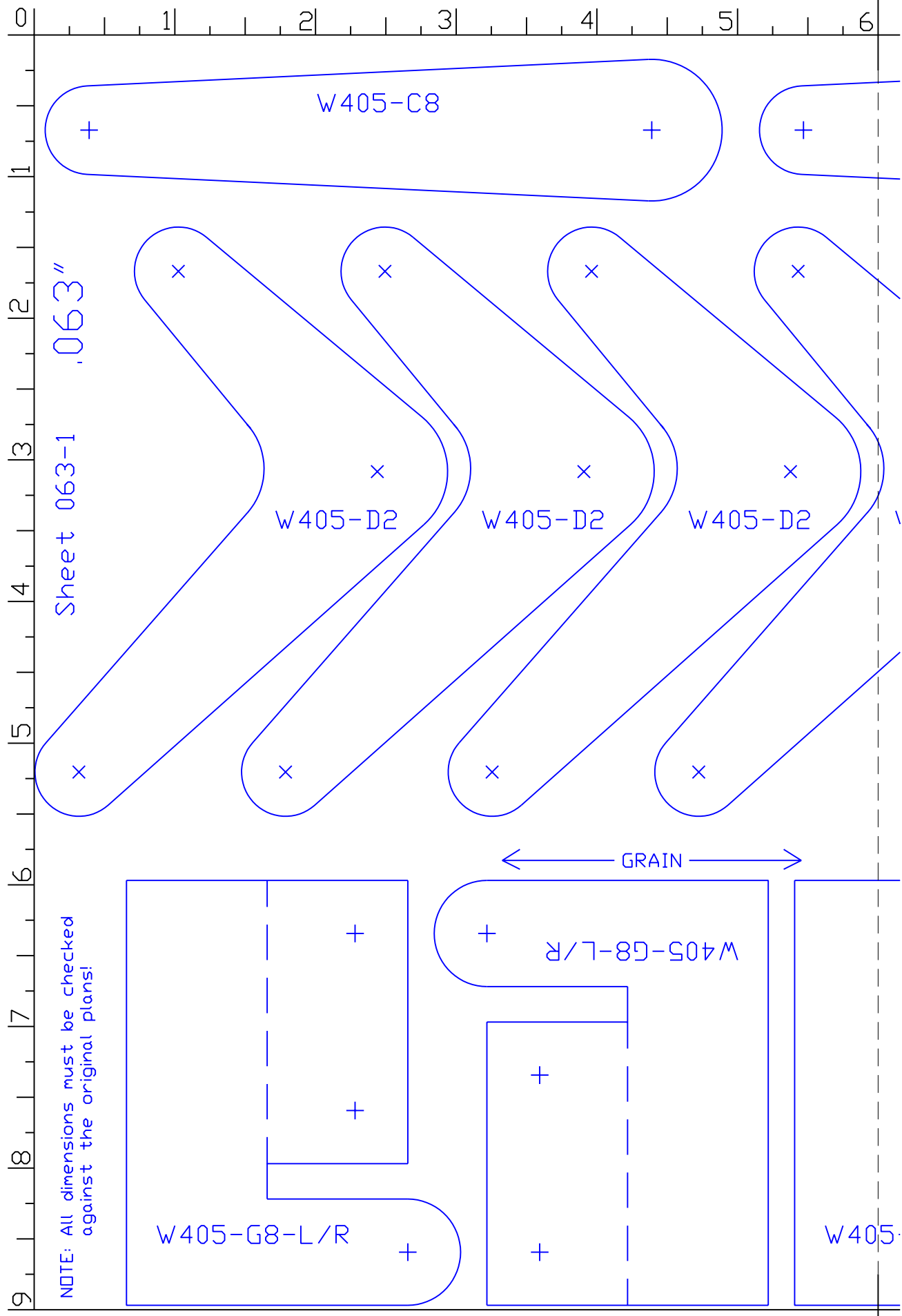

6

7

8

9

10

11

12

W405-C8

+

T305-B6

+

+

W405-F6

+

+

+

x

W405-D2

W403-G8

+

+

T305-B6

+

+

W405-F6

+

W403-G8

T305-B6

+

+

+

+

+

W405-G8-L/R

+

+

+

405-G8-L/R

+

+

+

12 | 13 | 14 | 15 | 16 | 17 | 18

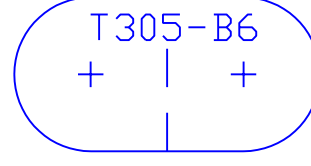
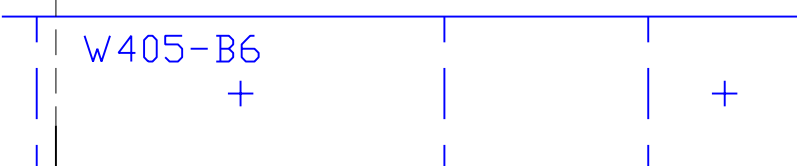
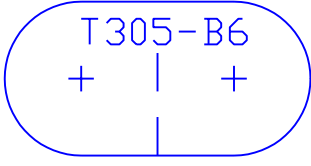
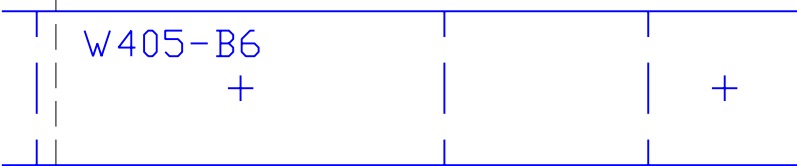
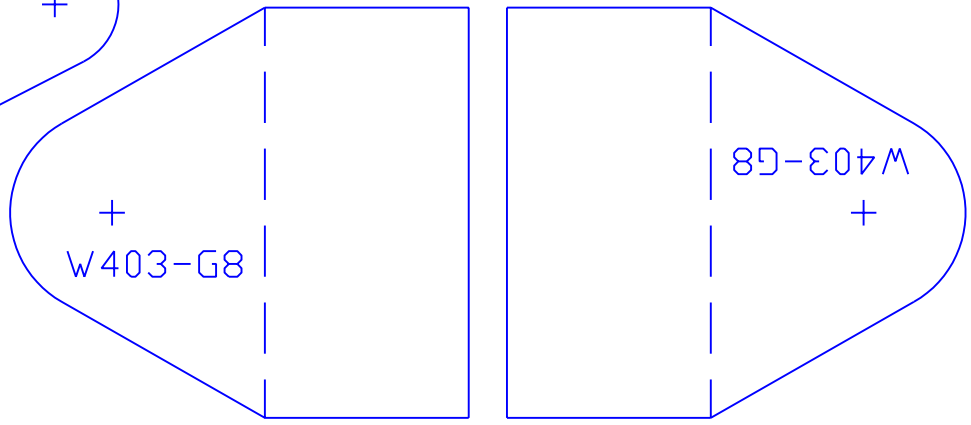
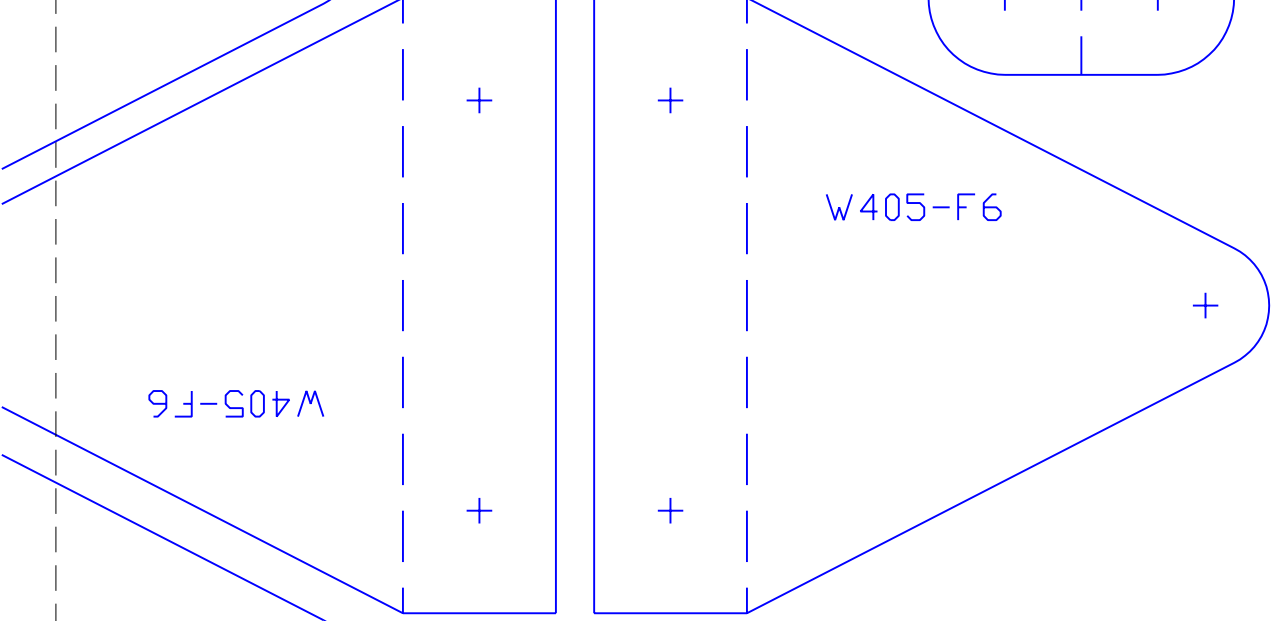
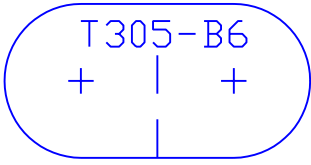
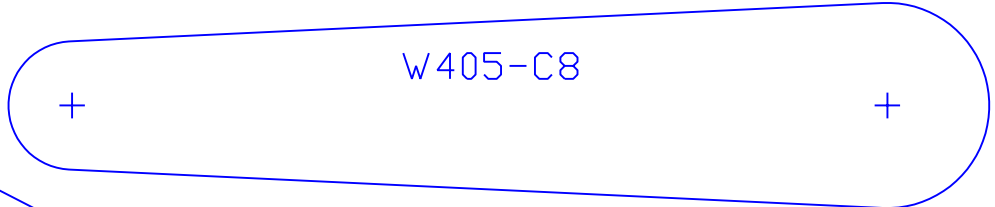

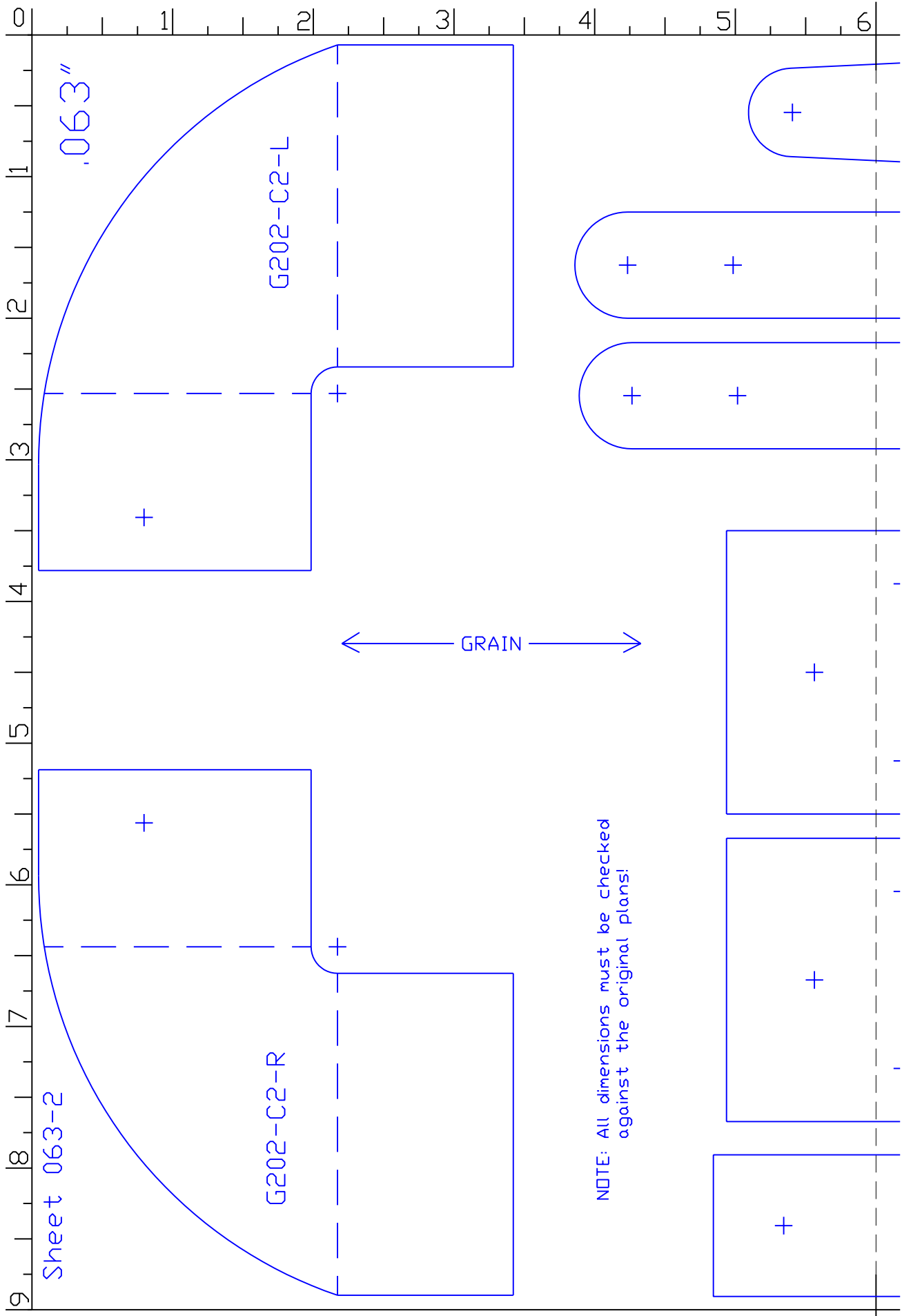

NOTE: All dimensions must be checked against the original plans!

6 7 8 9 10 11 12

W405-C8

+

T305-C

+

+

M605-B6

+

+

T305-C

+

+

M605-B6

+

+

T305-C

+

+

T308-G5

+

+

+

T305-C

+

+

+

+

T305-C

+

+

T308-G5

+

+

+

T305-C

+

+

+

+

T305-C

+

+

G206-D5

+

+

+

T305-C

+

+

T305-C

+

+

305-C7-I
+ | +

+ | T305-C7-□ | +

305-C7-I
+ | +

+ | T305-C7-□ | +

305-C7-I
+ | +

+ | T305-C7-□ | +

305-C7-I
+ | +

+ | T305-C7-□ | +

305-C7-I
+ | +

+ | T305-C7-□ | +

305-C7-I
+ | +

+ | T305-C7-□ | +

305-C7-I
+ | +

+ | T305-C7-□ | +

305-C7-I
+ | +

+ | T305-C7-□ | +

305-C7-I
+ | +

+ | T305-C7-□ | +

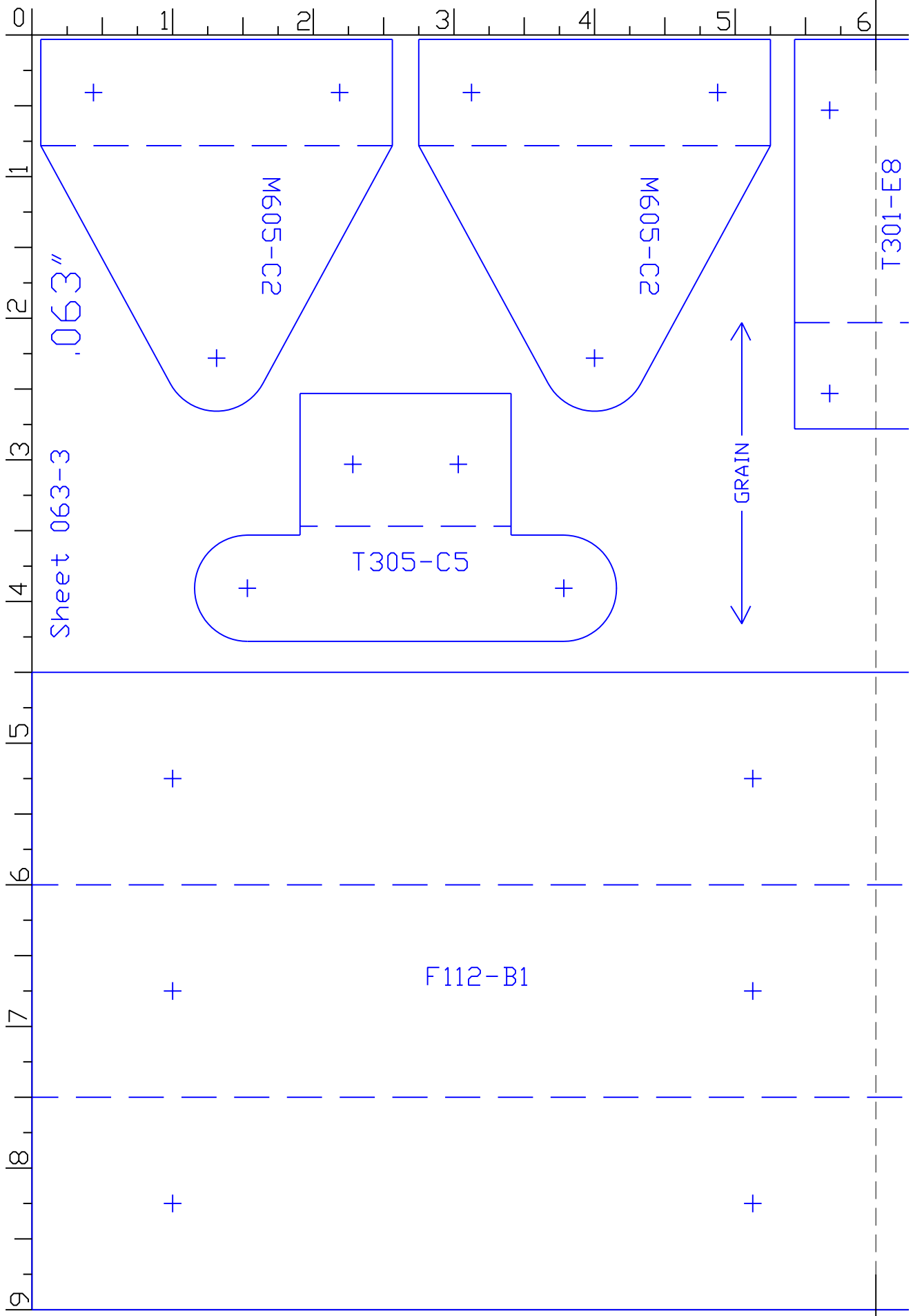

6 7 8 9 10 11 12

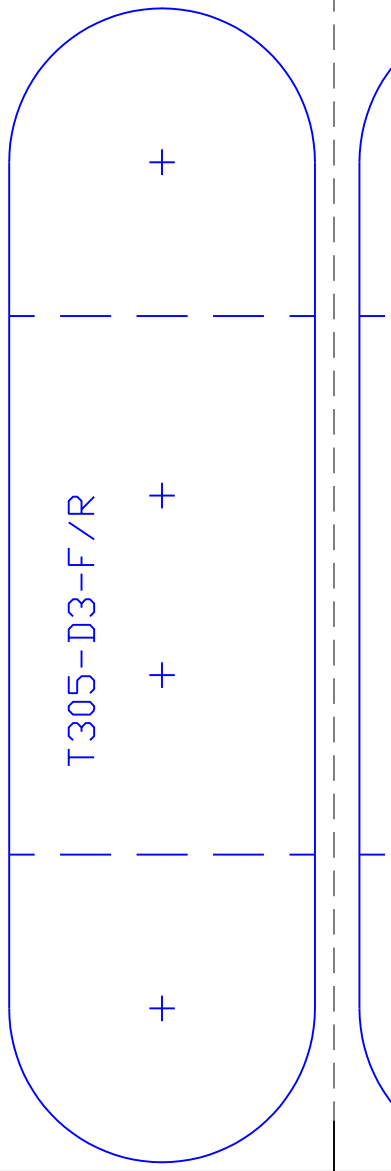
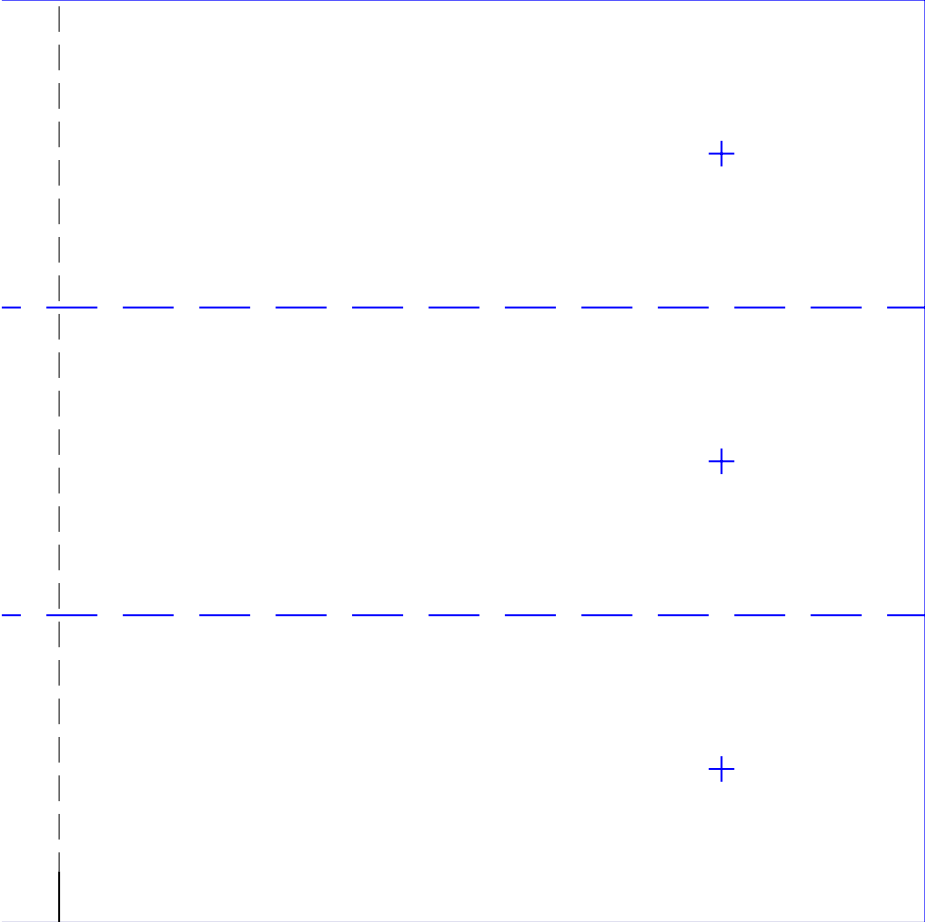
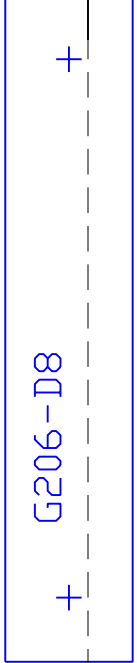
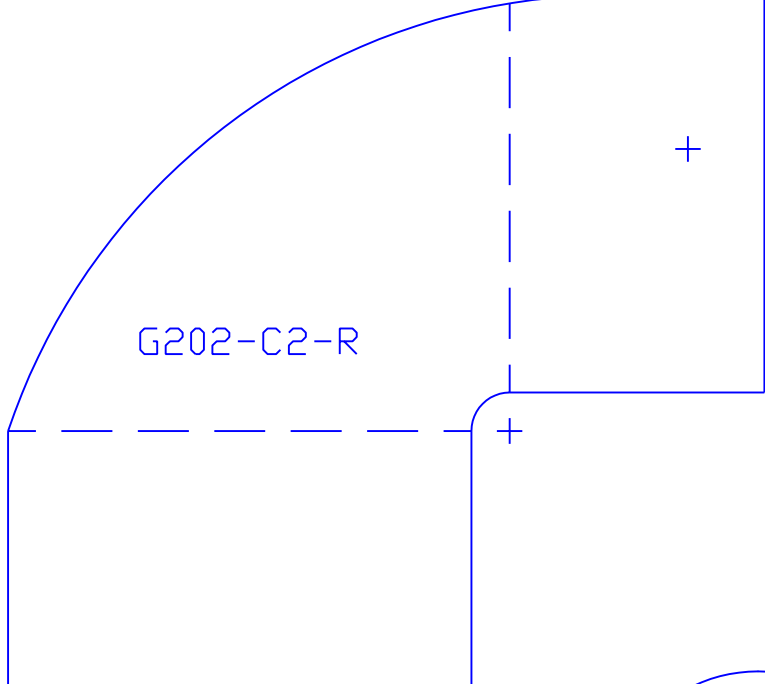
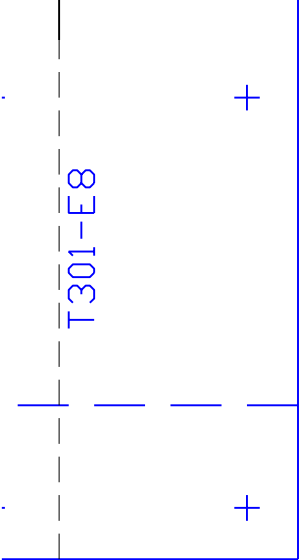

12 13 14 15 16 17 18

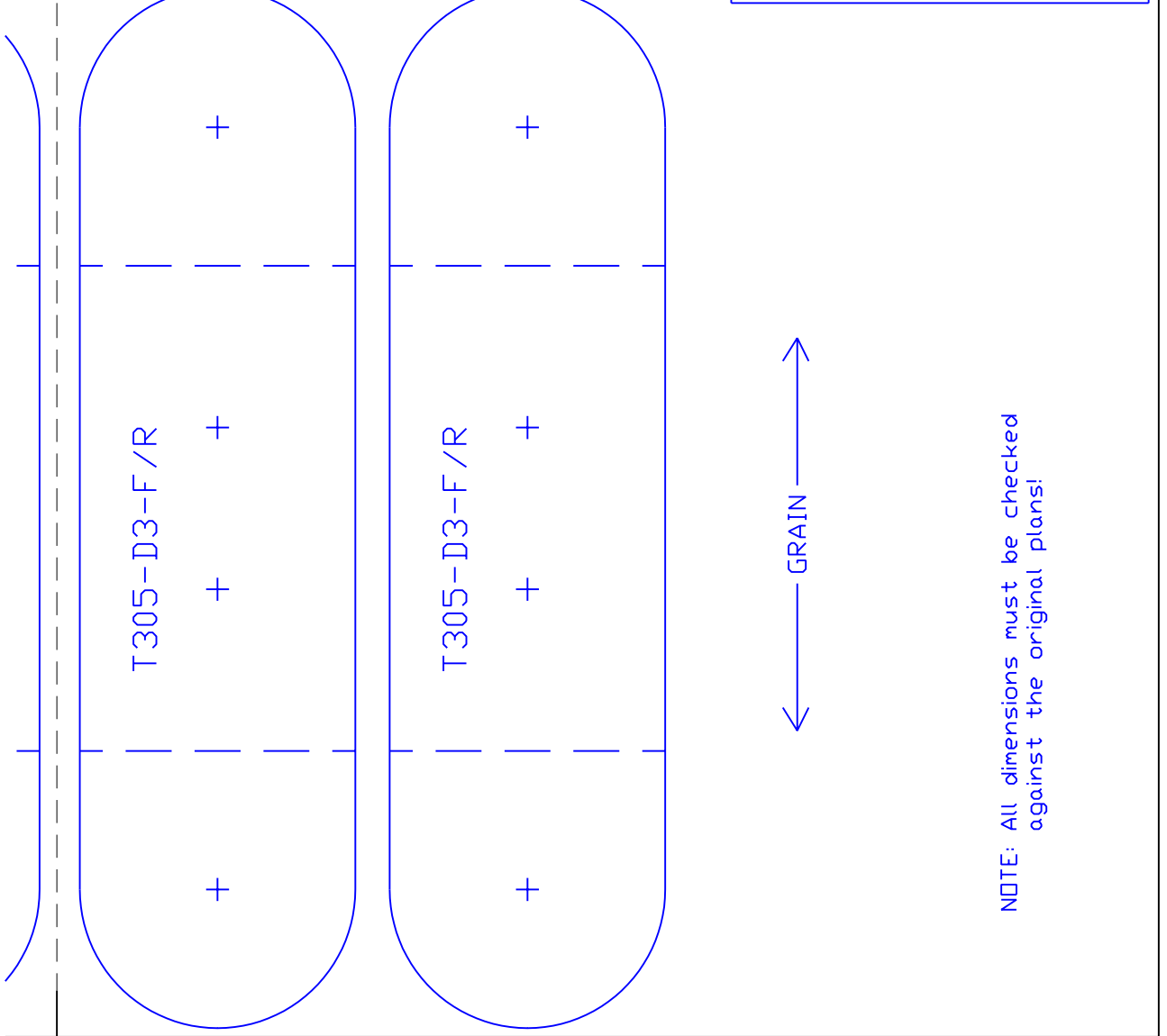
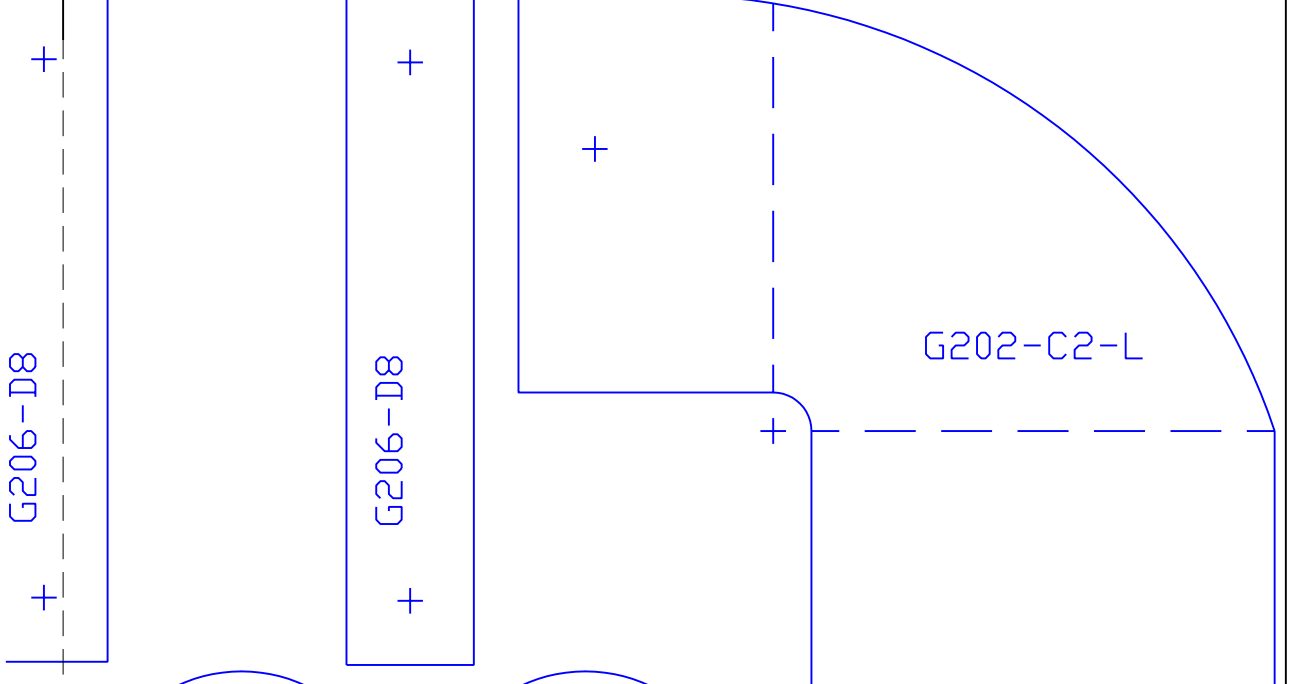

NOTE: All dimensions must be checked against the original plans!

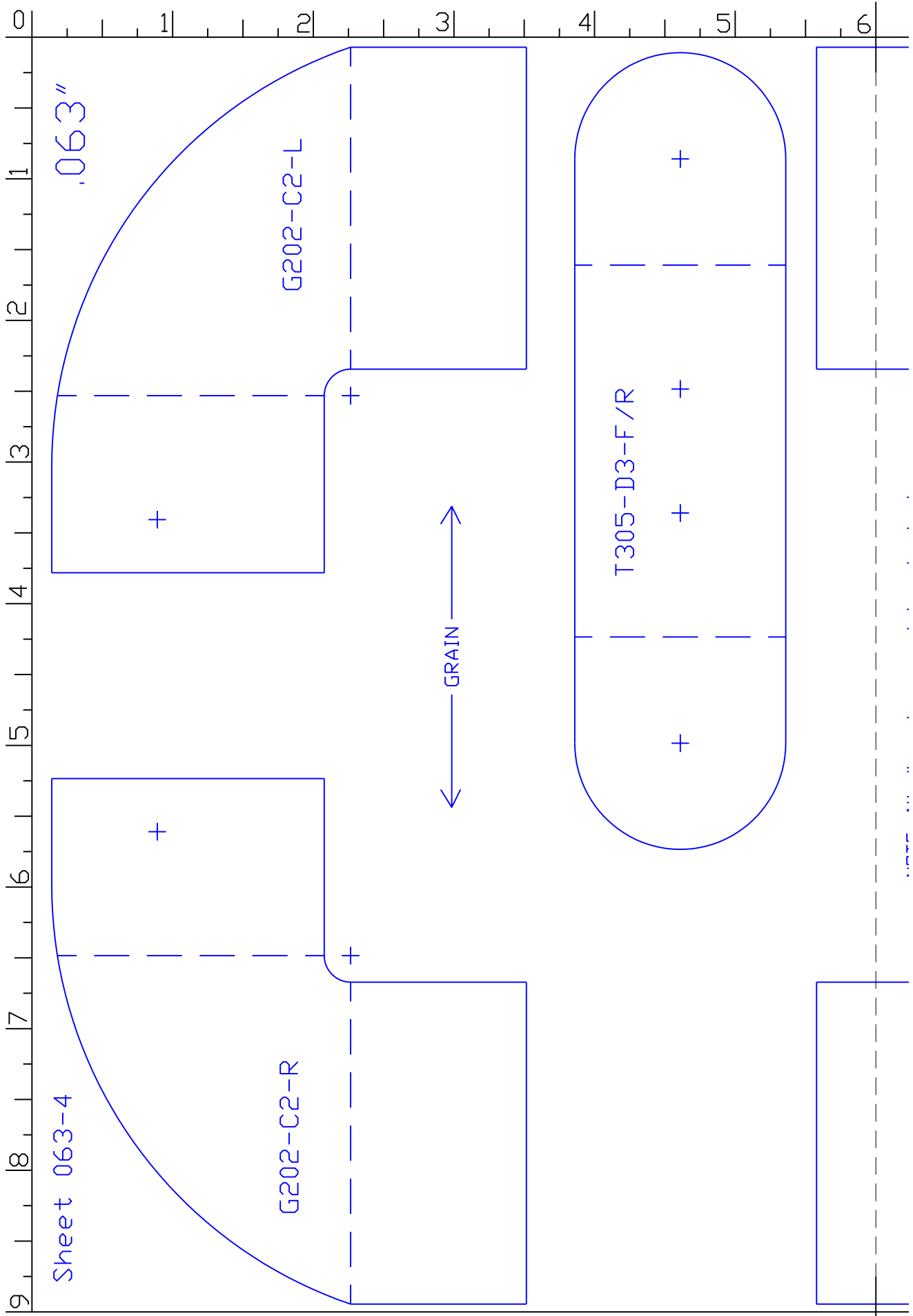

Sheet 063-4

Sheet 063-4

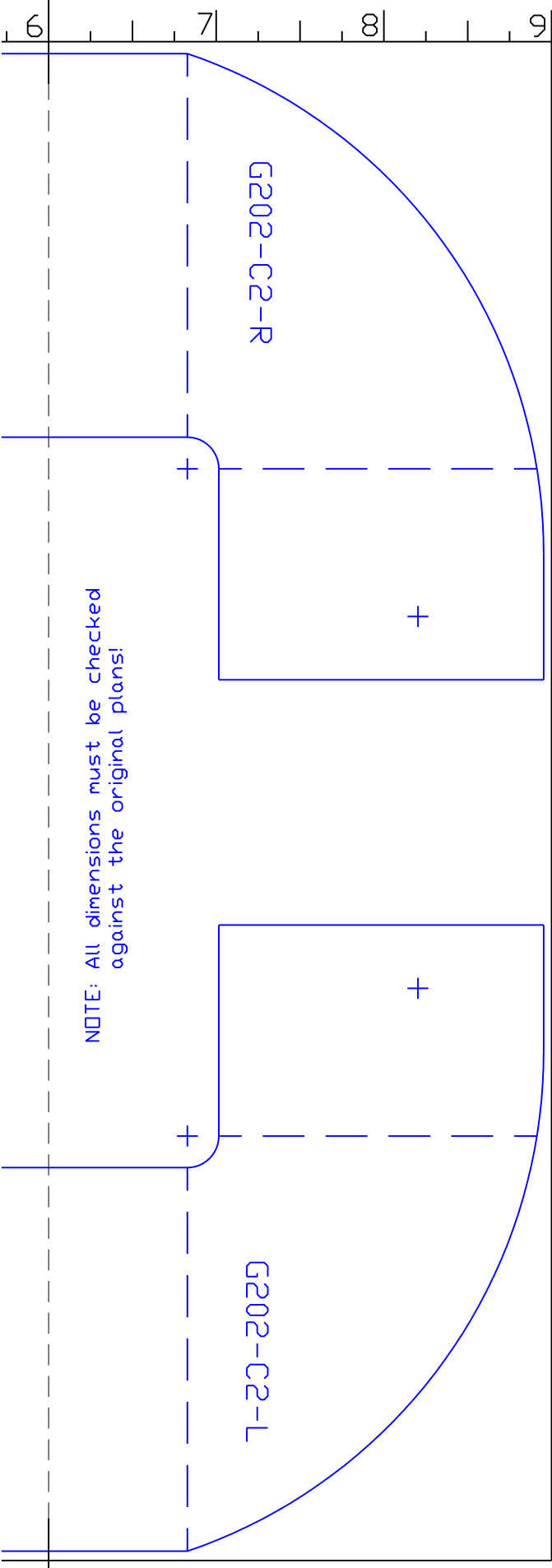

NOTE: All dimensions must be checked against the original plans!

G202-C2-R

G202-C2-L

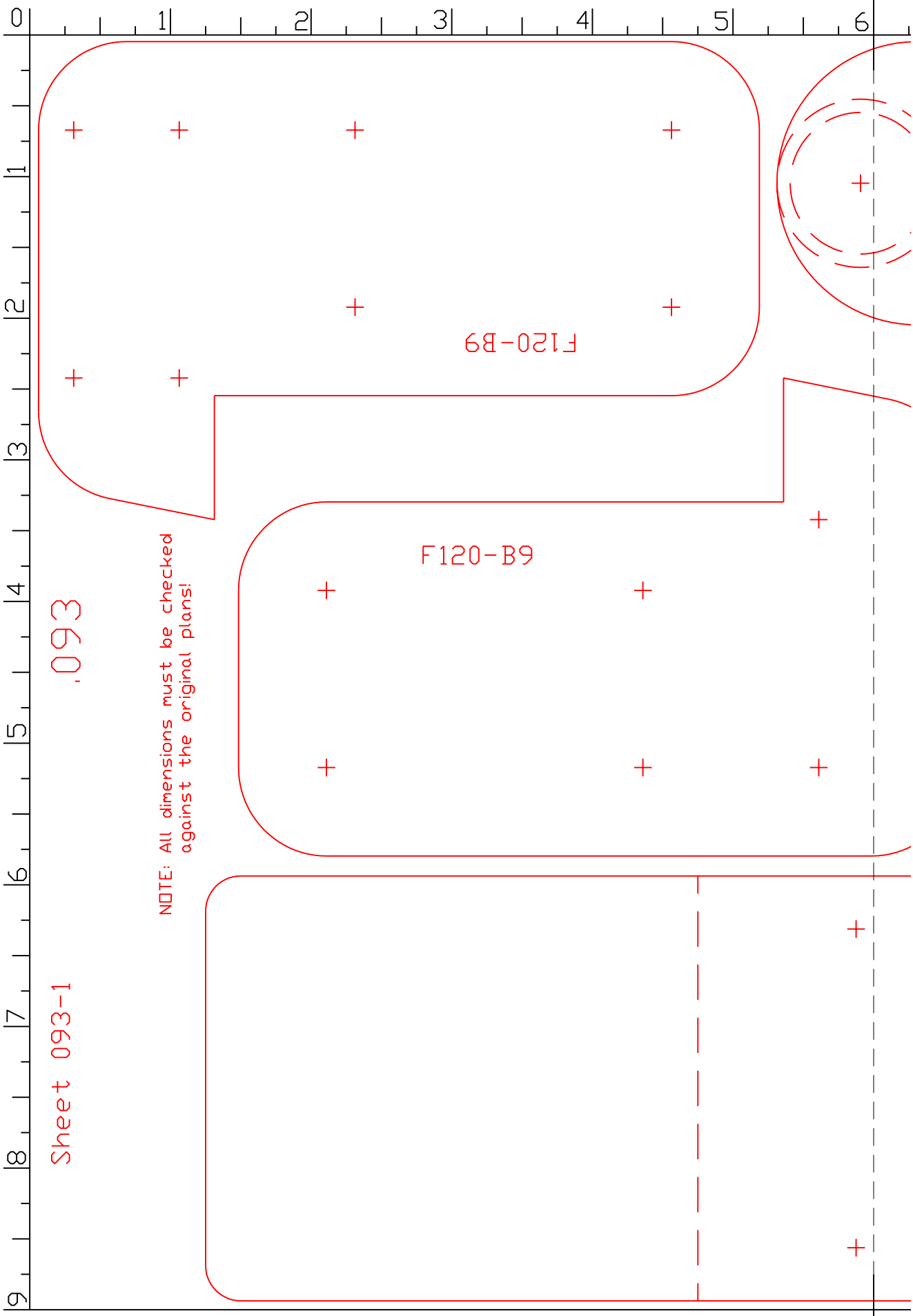

.093

NOTE: All dimensions must be checked against the original plans!

F120-B9

F120-B9

Sheet 093-1

Sheet 093-1

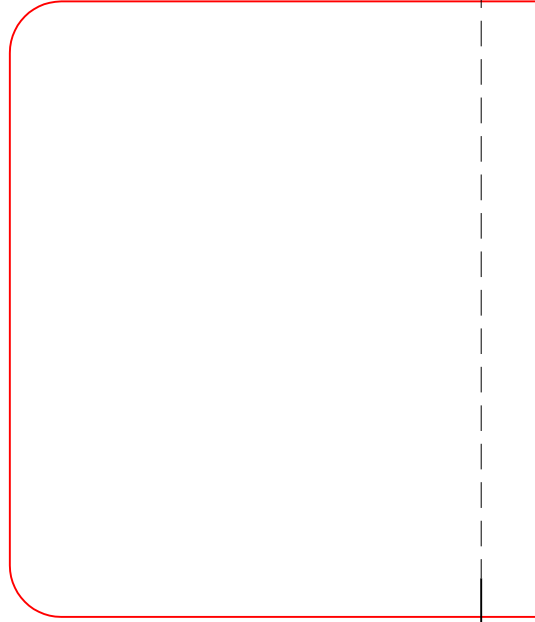
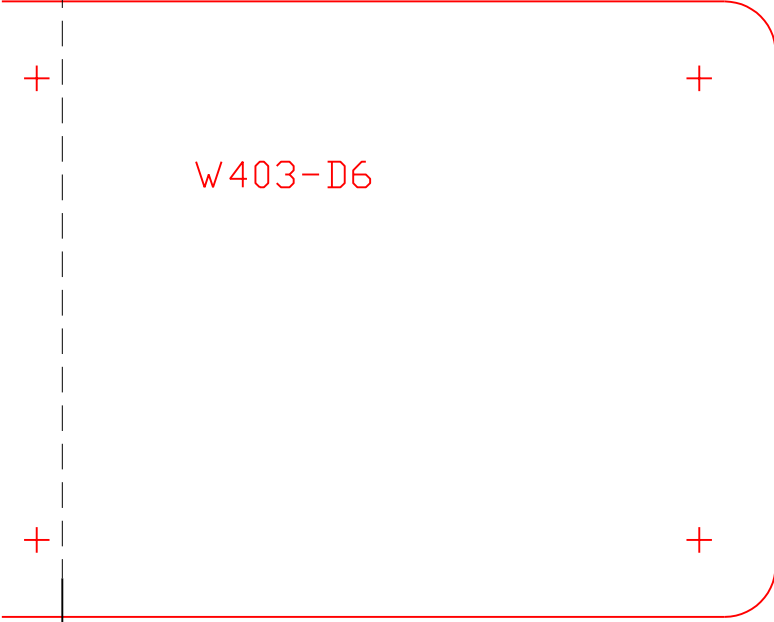
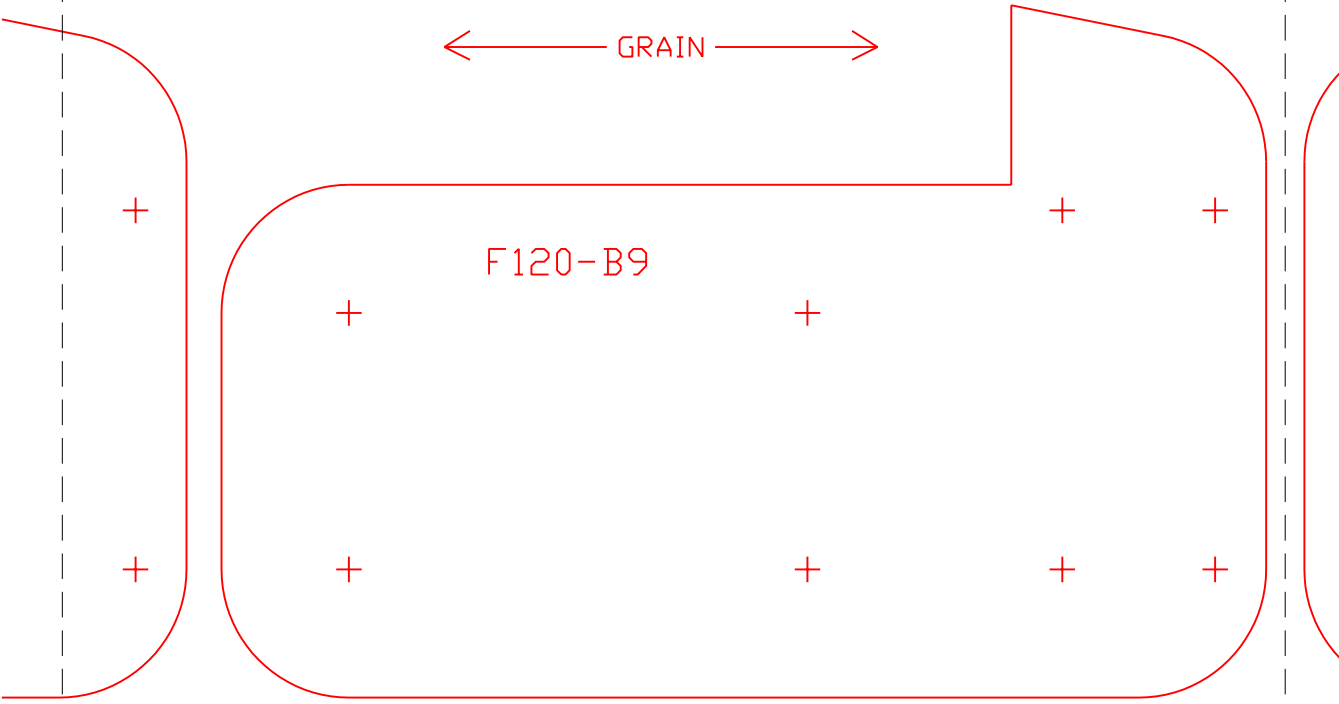
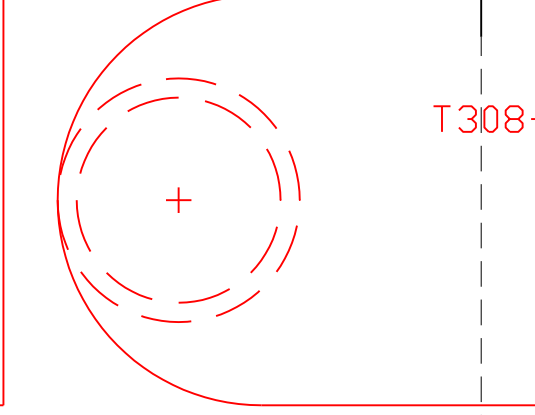
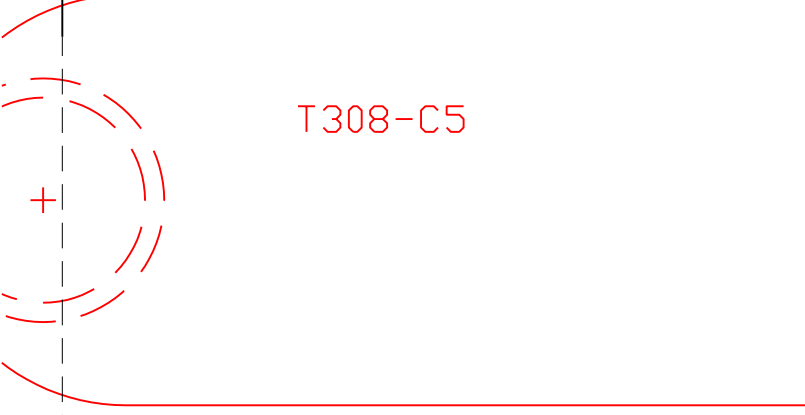
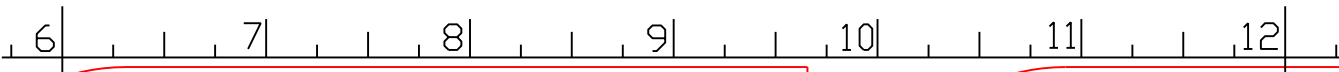

12 13 14 15 16 17 18

T308-C5

W403-B8

F120-B9

W403-D6

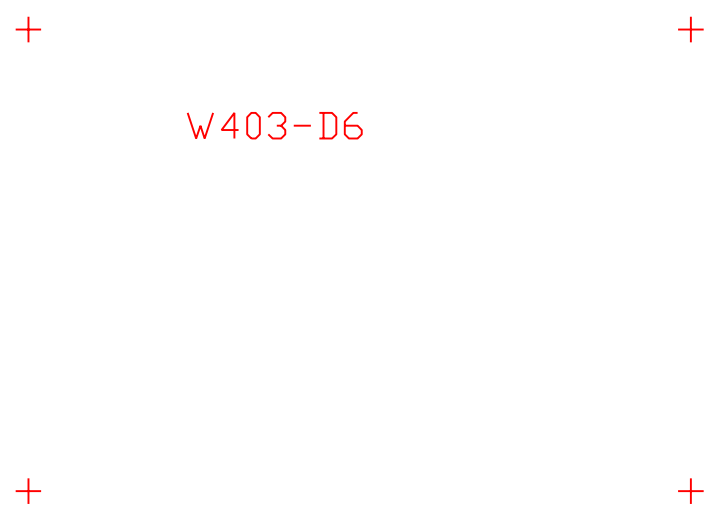
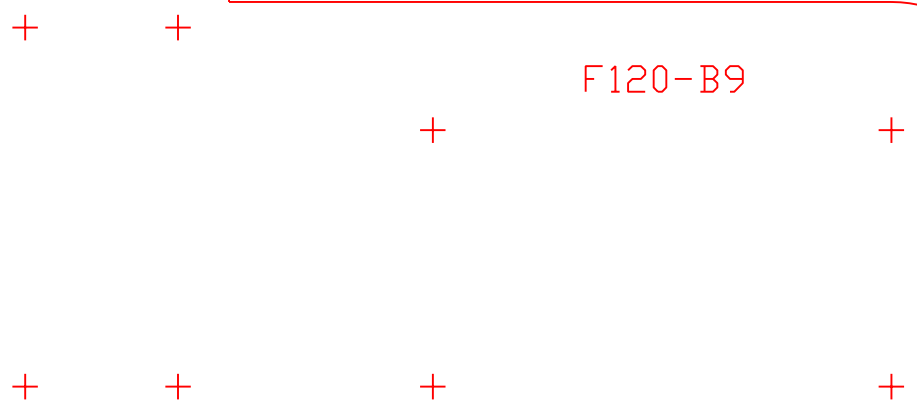

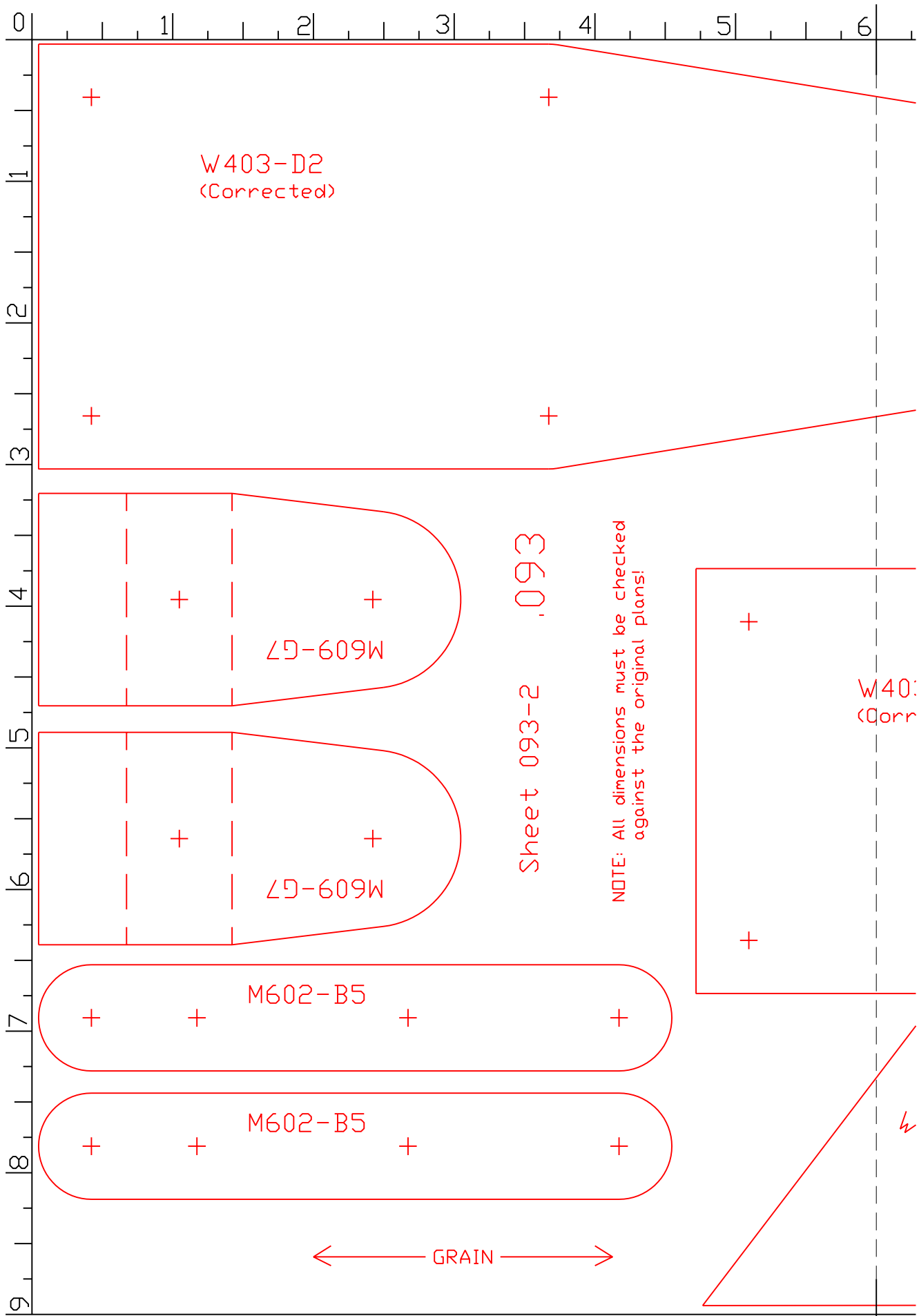

W403-D2
(Corrected)

M609-G7

M609-G7

M602-B5

M602-B5

W40:
(Corr)

Sheet 093-2 .093

NOTE: All dimensions must be checked
against the original plans!

← GRAIN →

6 7 8 9 10 11 12

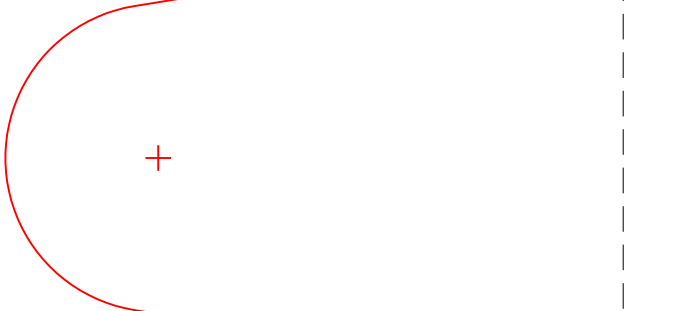
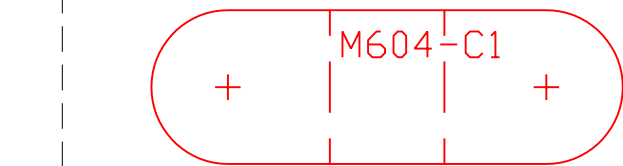
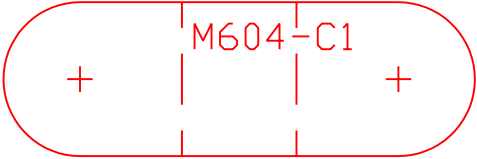
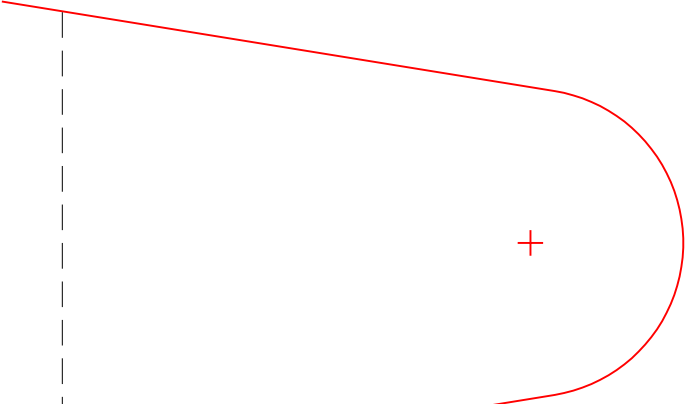

W403-D2
(Corrected)

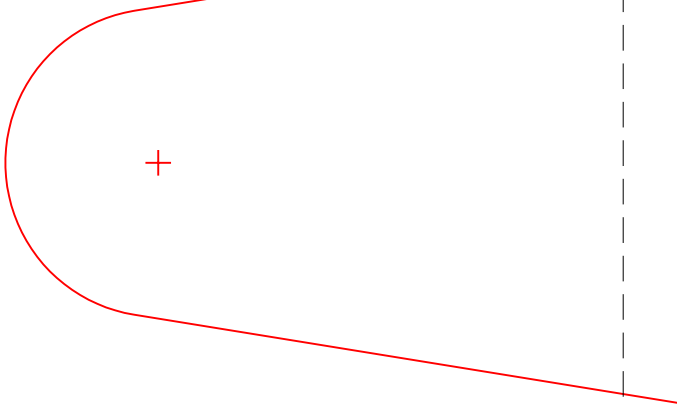
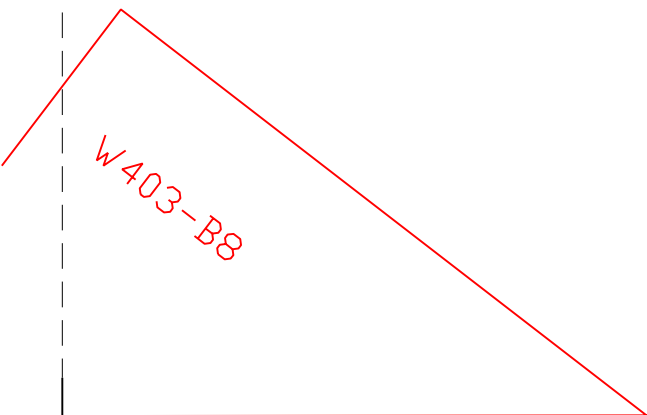

12 | 13 | 14 | 15 | 16 | 17 | 18

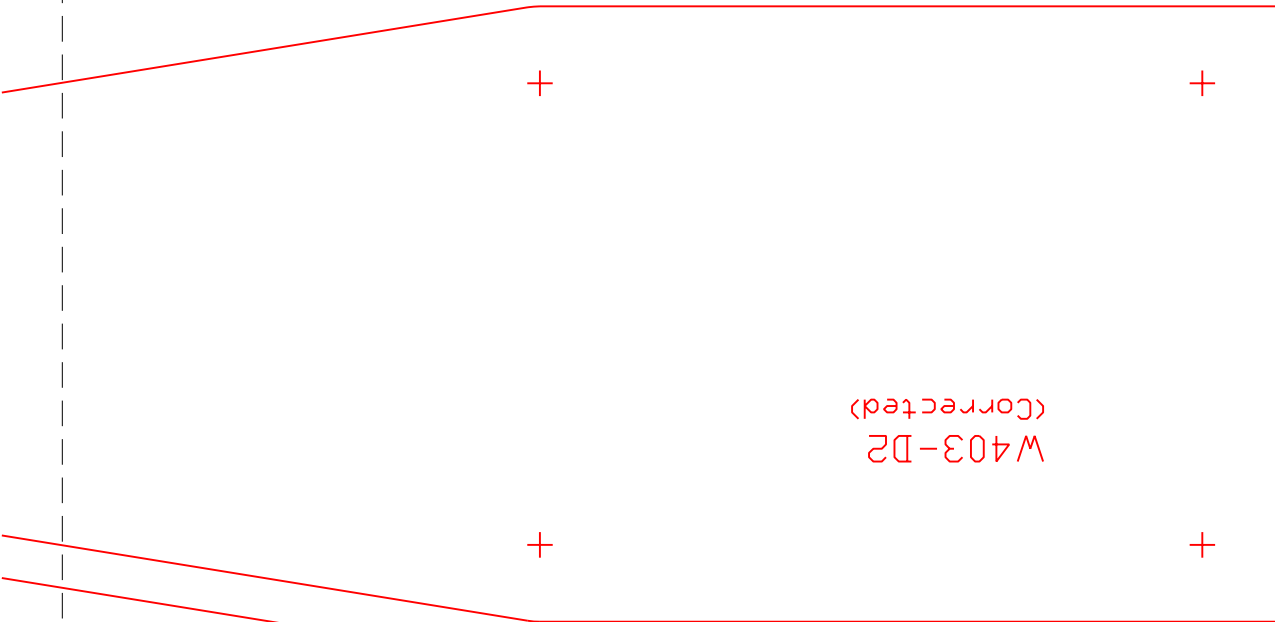
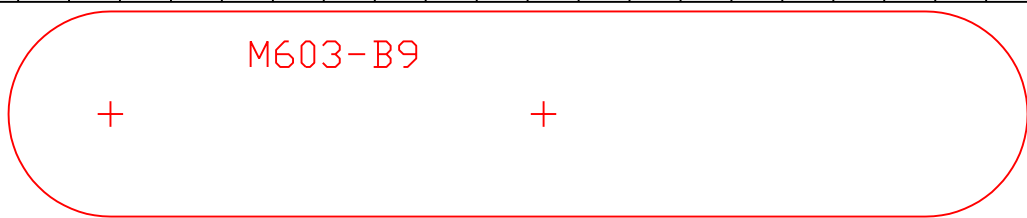

W403-D2
(Corrected)

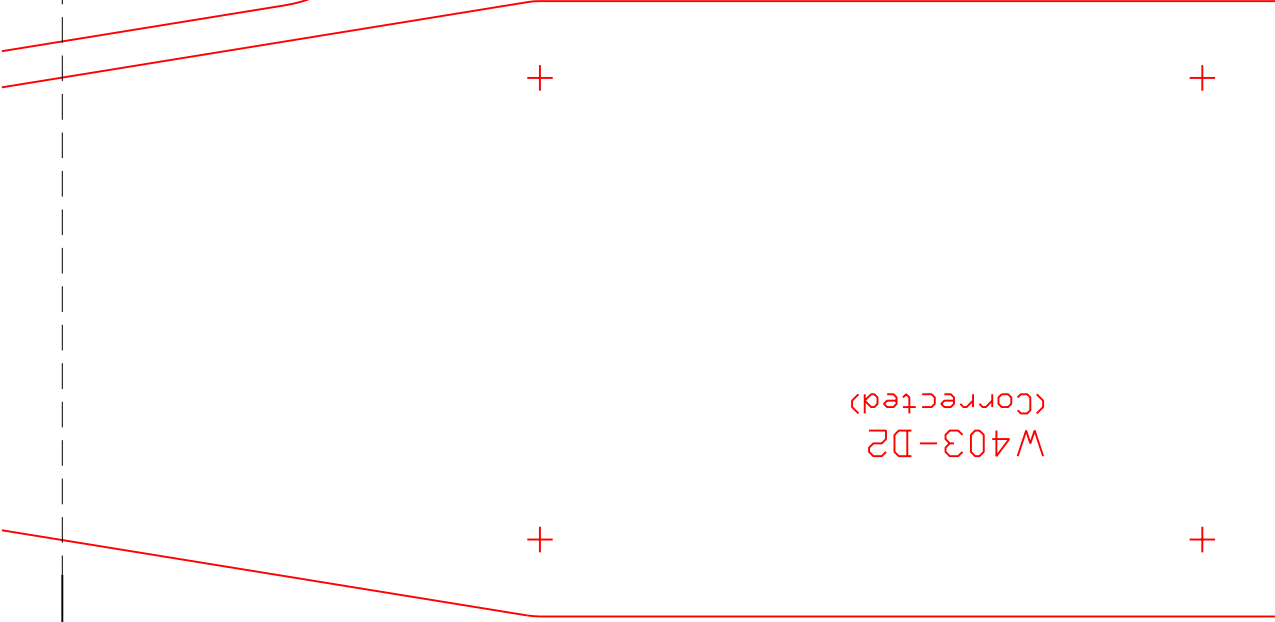
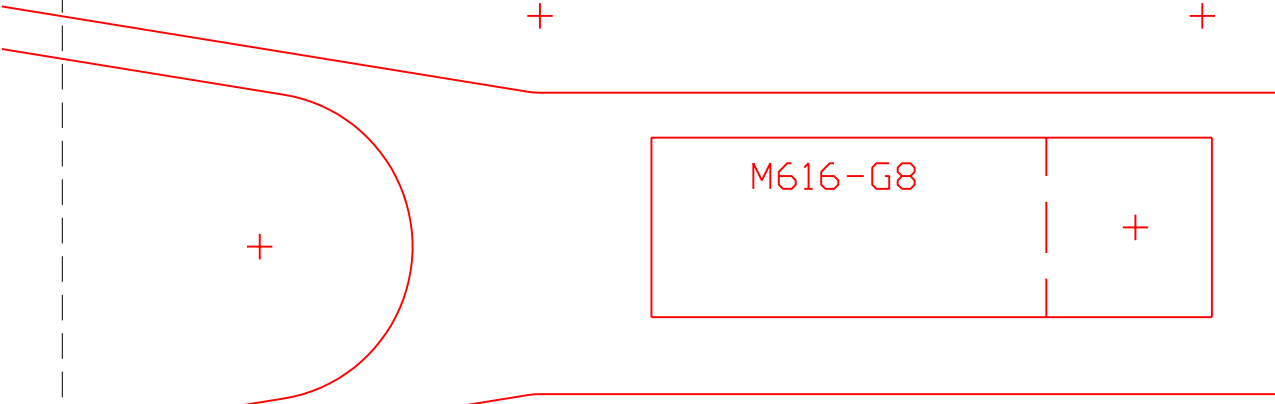

W403-D2
(Corrected)

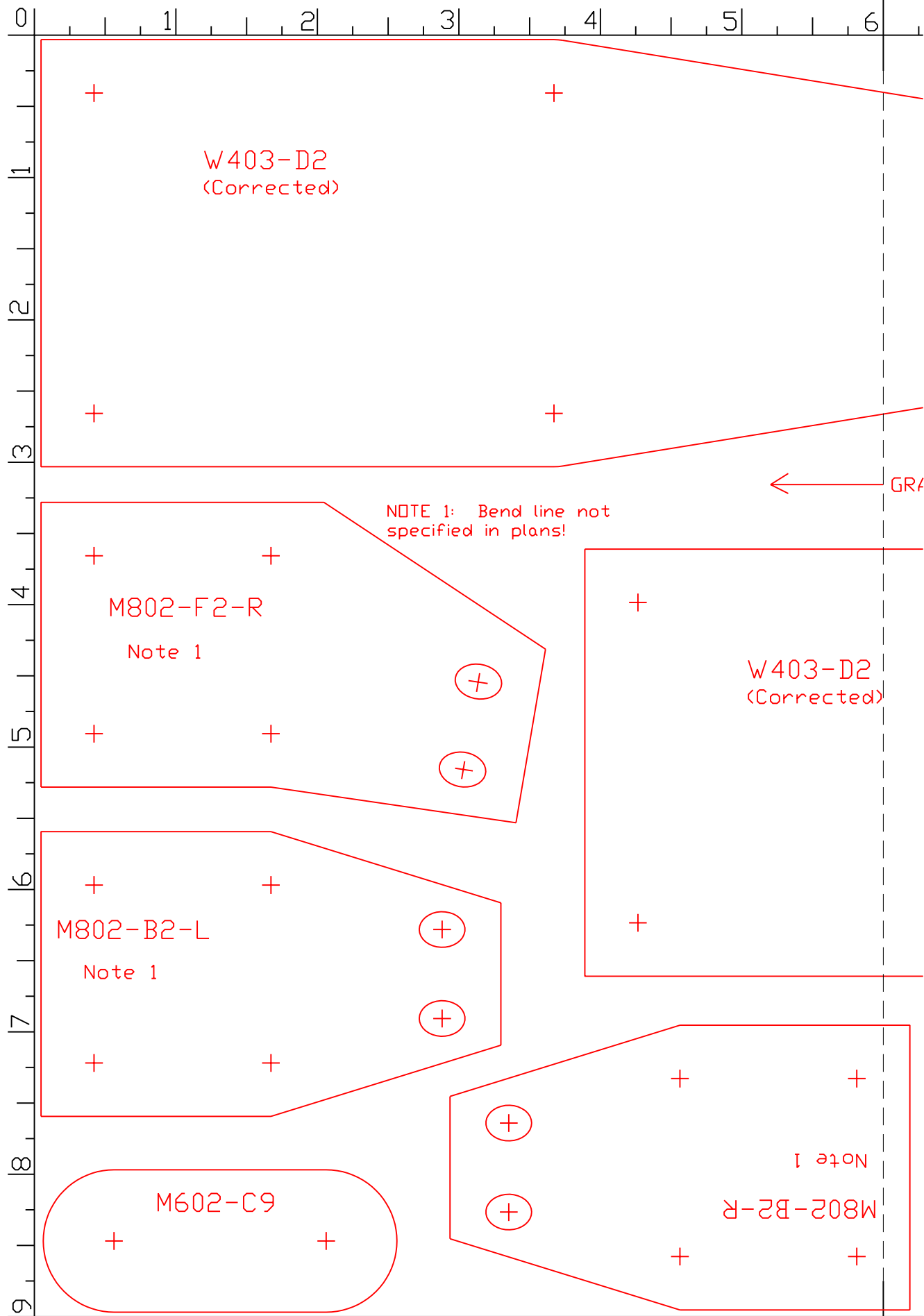

W403-D2
(Corrected)

M802-F2-R
Note 1

NOTE 1: Bend line not
specified in plans!

W403-D2
(Corrected)

M802-B2-L
Note 1

M602-C9

M802-B2-R
Note 1

GRF

6 7 8 9 10 11 12

M616-G8 +

NOTE: All dimensions must be checked against the original plans!

.093
Sheet 093-3

GRAIN →

2
(rad)

+
ON
8W
+

M602-C9 + +

M602-C9 + +

12 13 14 15 16 17 18

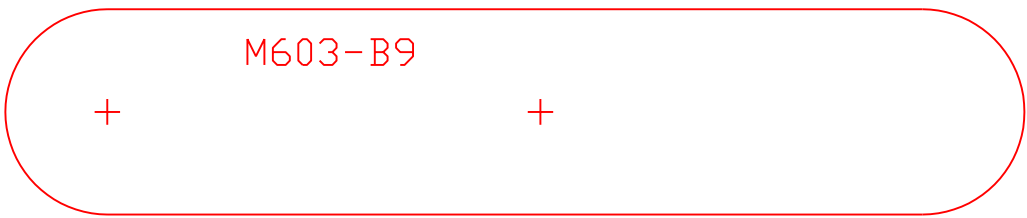

M603-B9

+

+

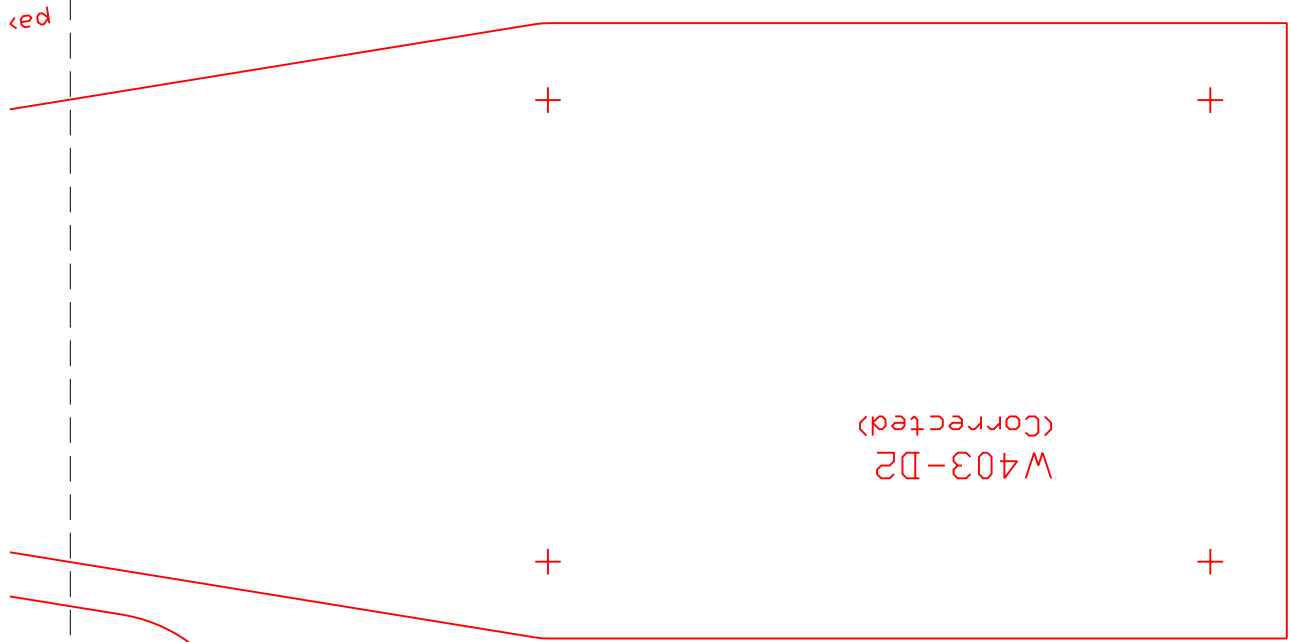

W403-D2
(Corrected)

+

+

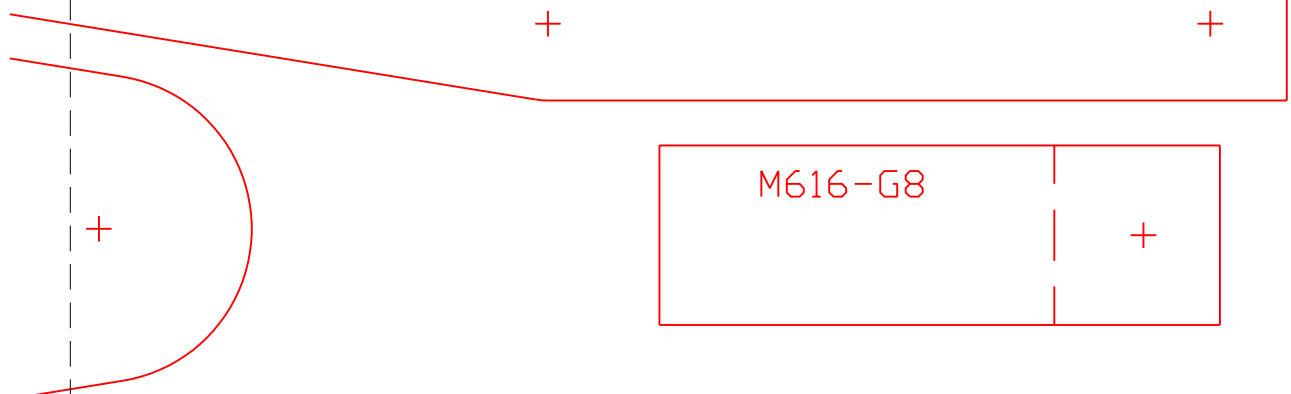

M616-G8

+

+

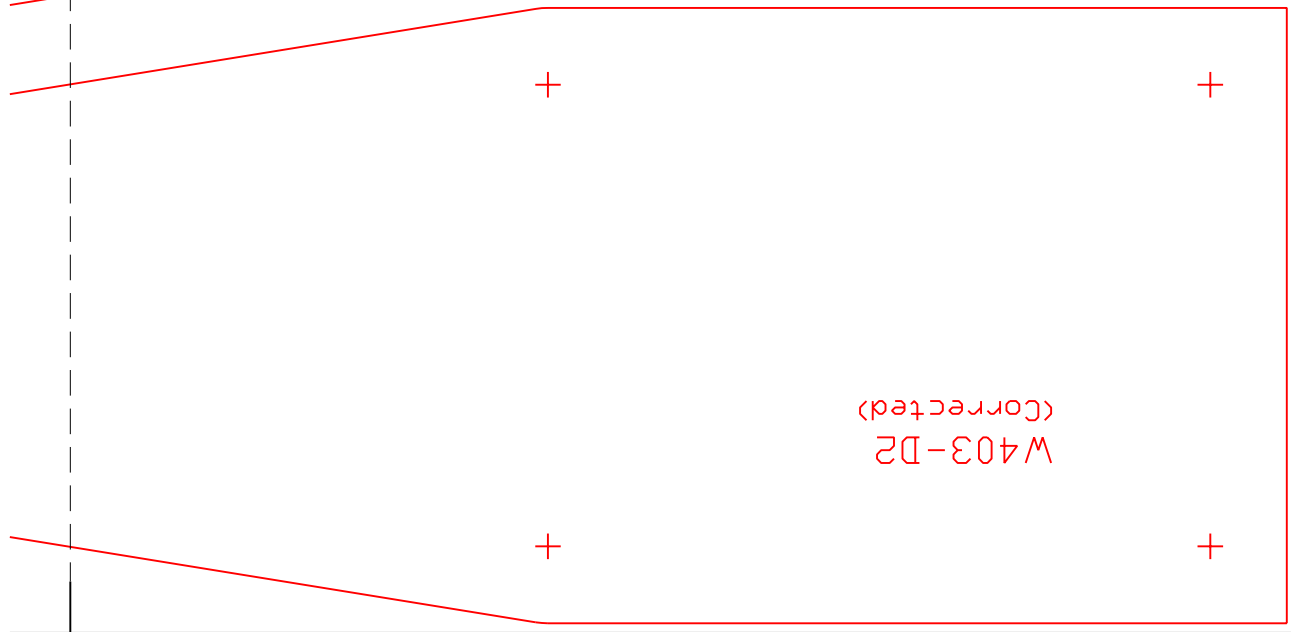

W403-D2
(Corrected)

+

+

+

+

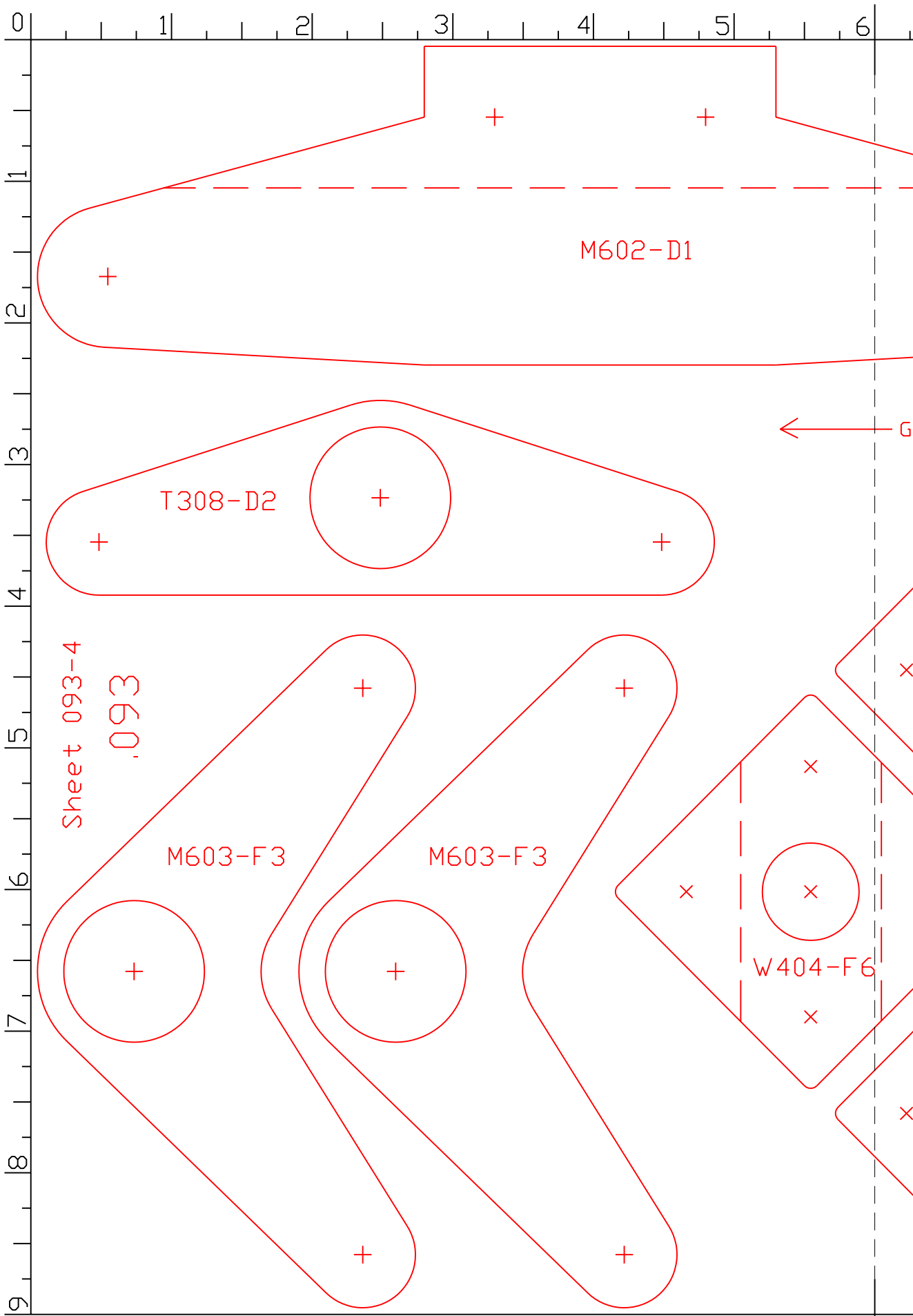

6 7 8 9 10 11 12

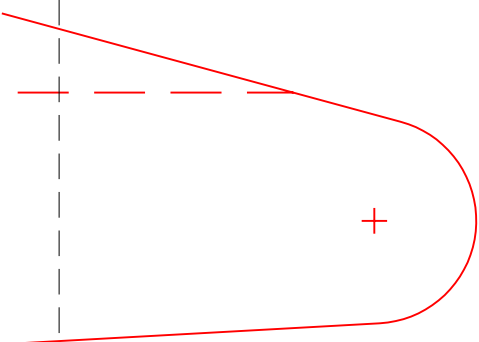

NOTE: All dimensions must be checked against the original plans!

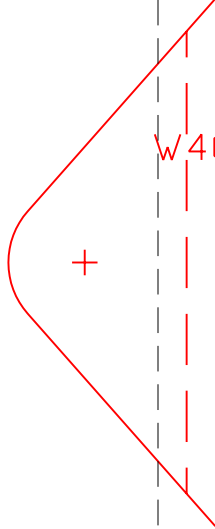
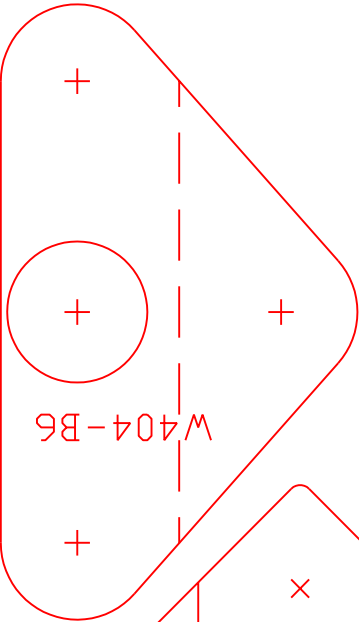

GRAIN →

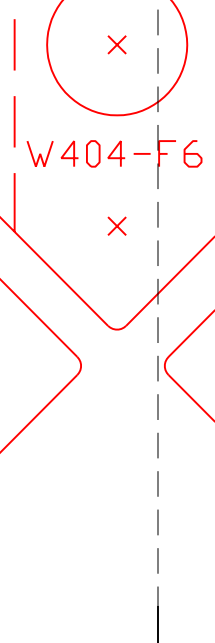
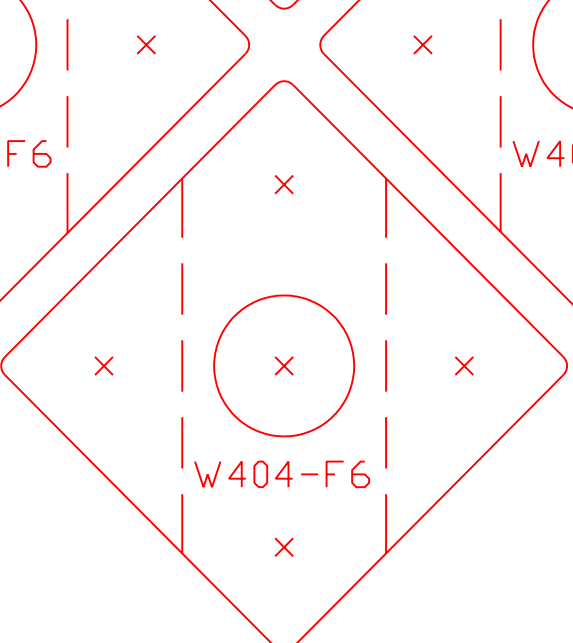
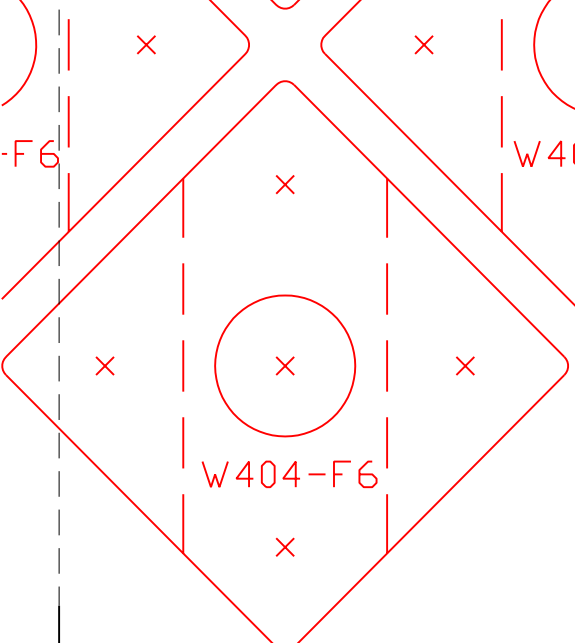
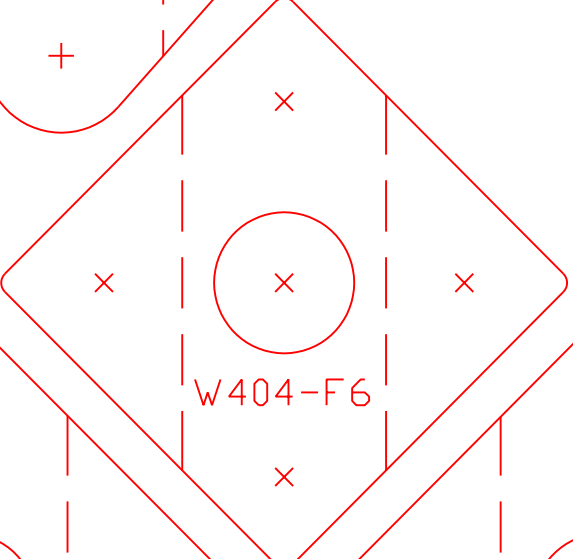
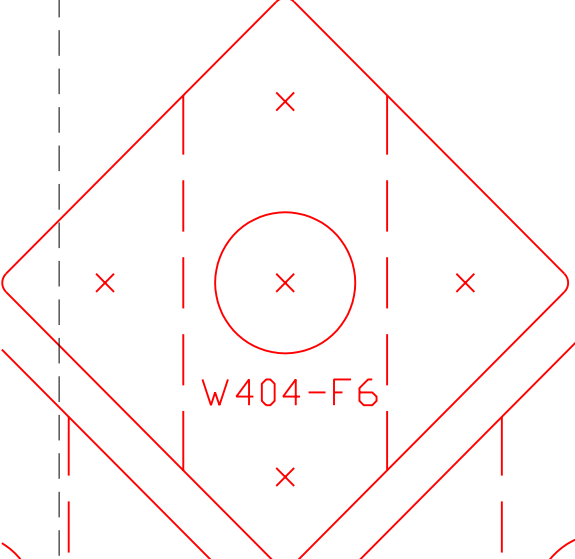

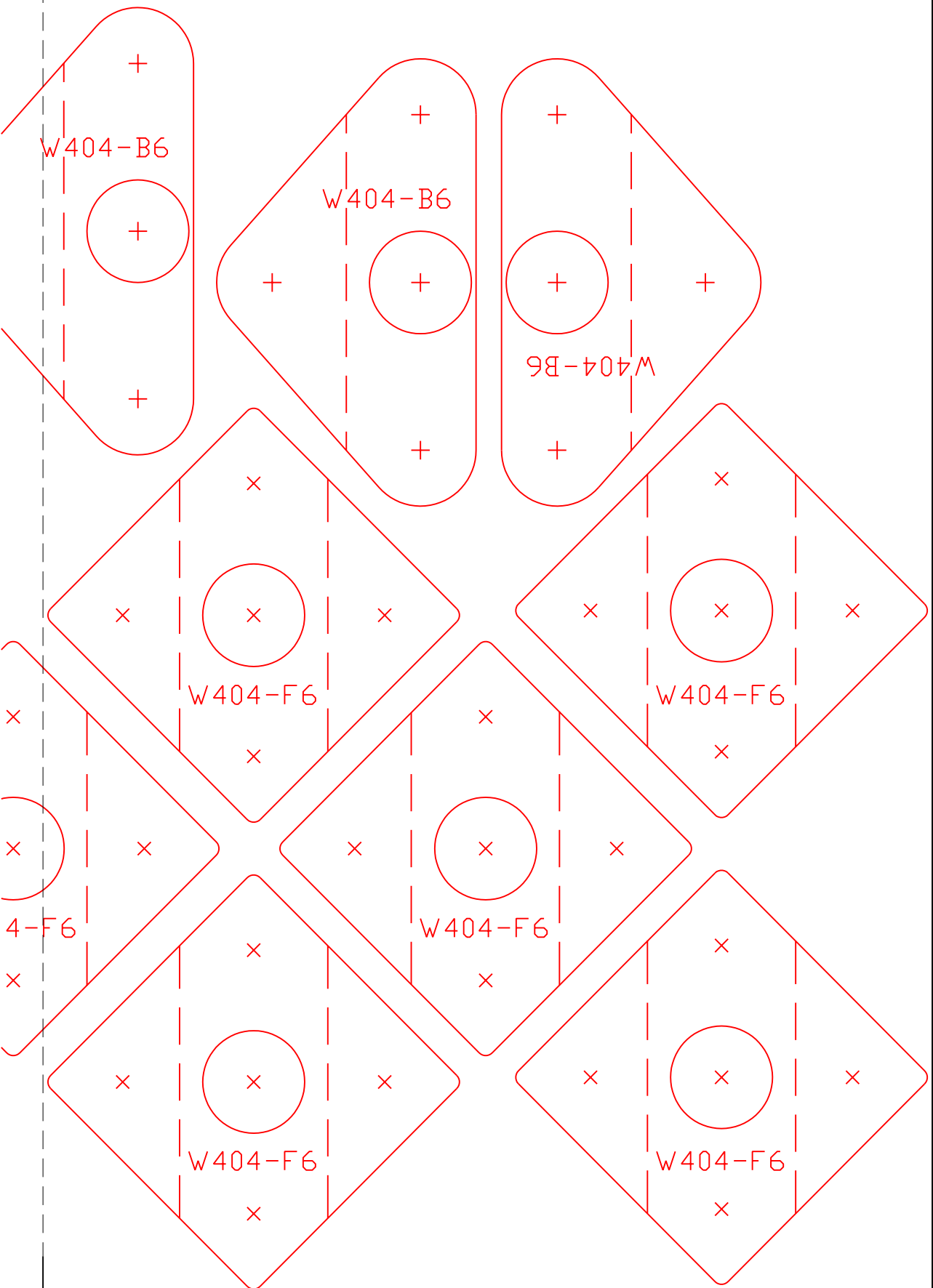

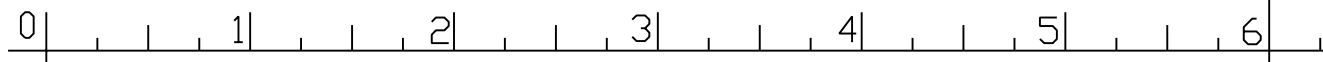

Sheet 093-5
.093

NOTE: All dimensions must be checked
against the original plans!

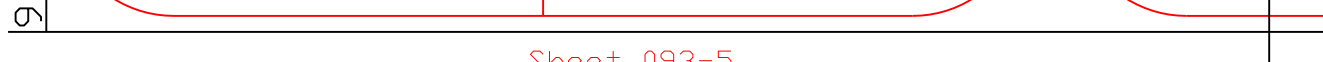
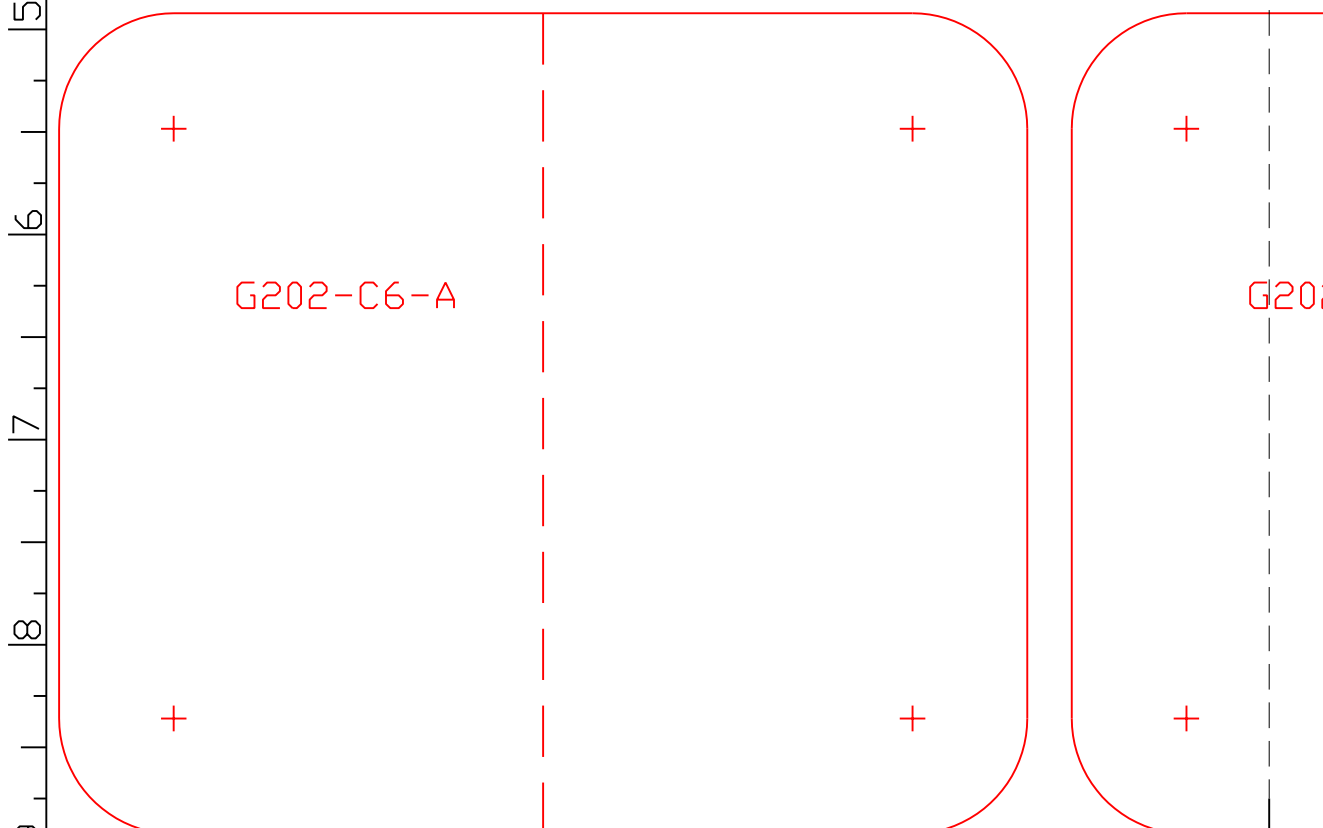
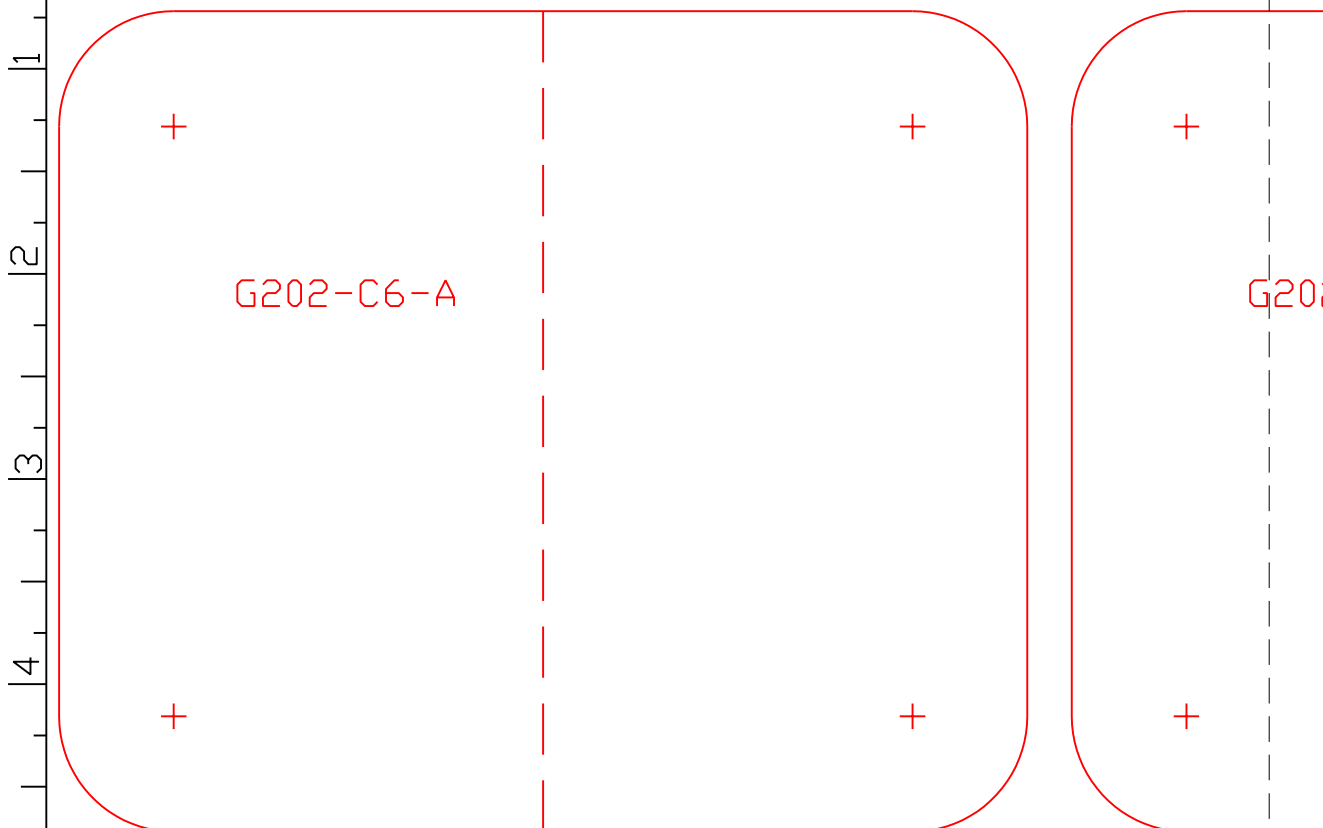

6 7 8 9 10 11 12

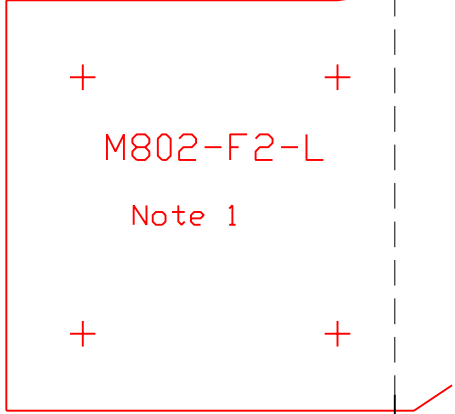
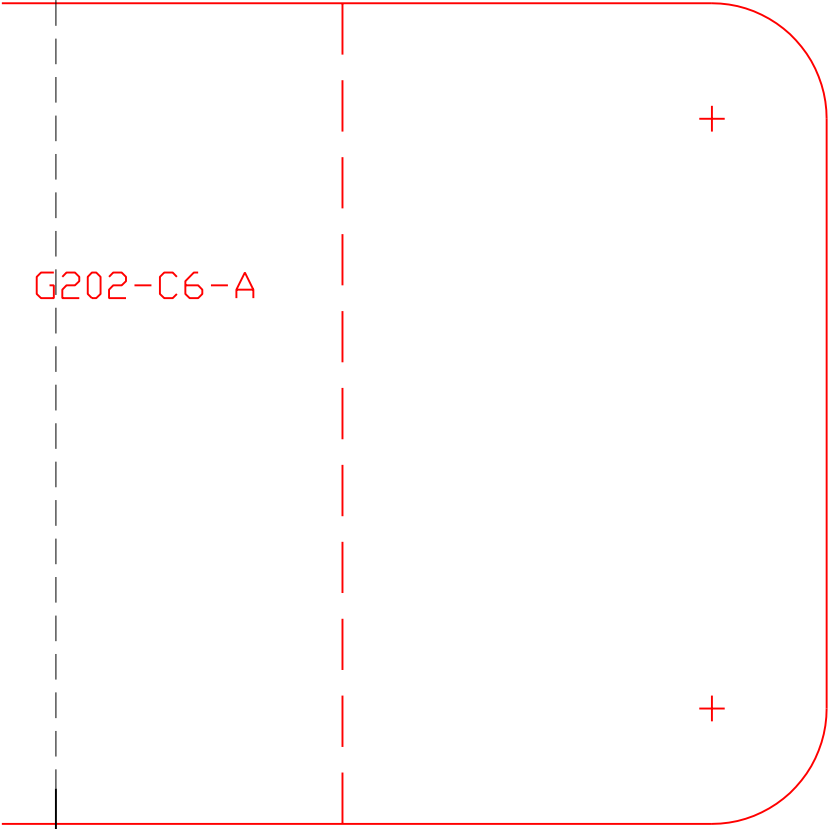
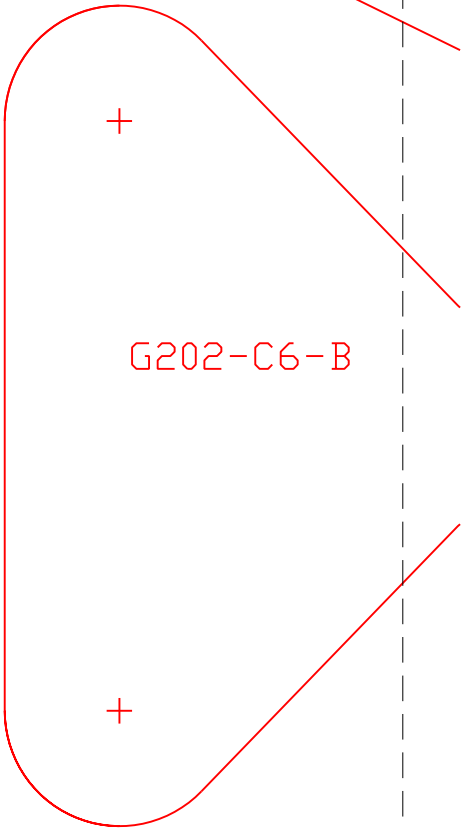
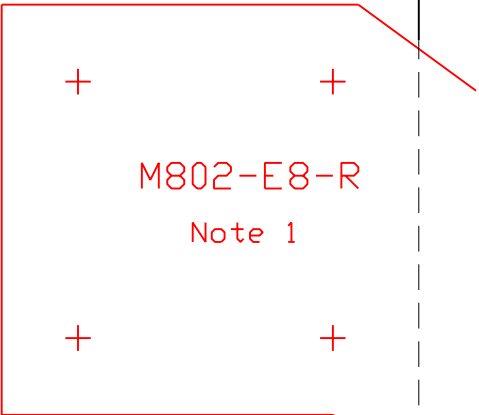
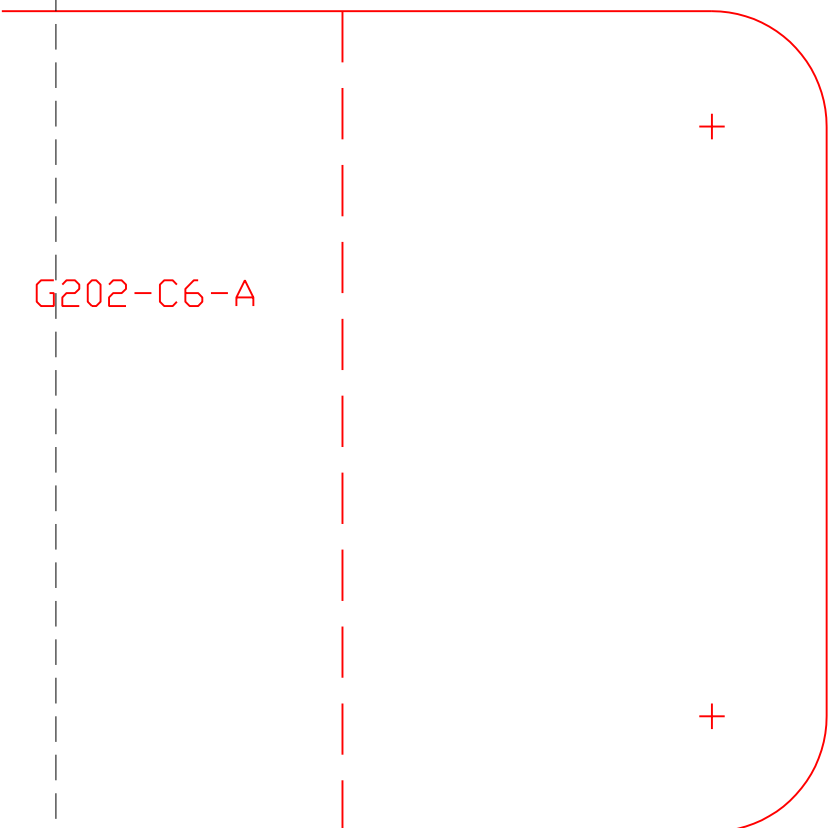

NO
spe

12 13 14 15 16 17 18

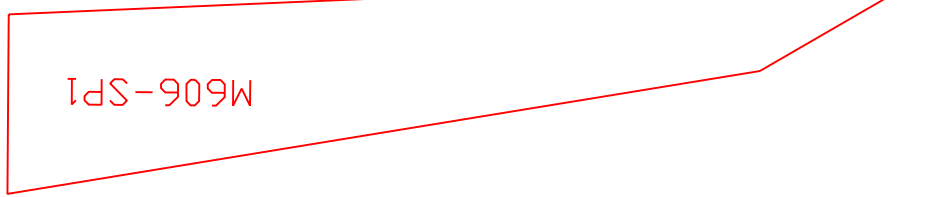

M606-SP1

← GRAIN →



M606-SP1



+

+

+

+



M802-E8-L

Note 1

+

+

+

+

+

+

+

+

NOTE 1: Bend line not specified in plans!

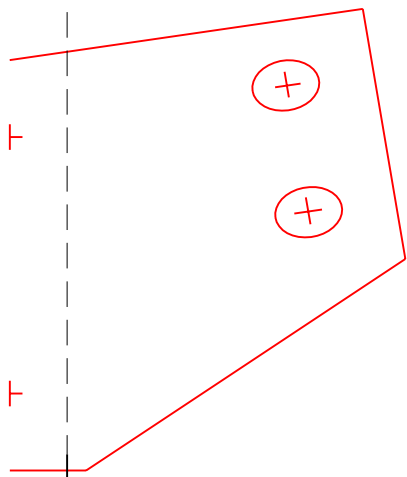

+

+

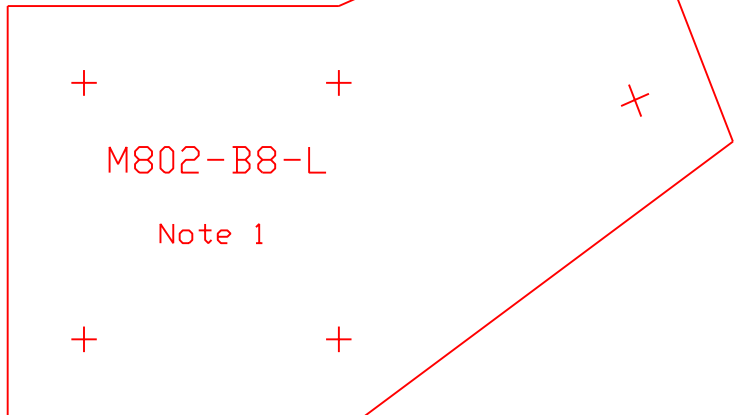

M802-B8-L

Note 1

+

+

+

+

+

+

+

+

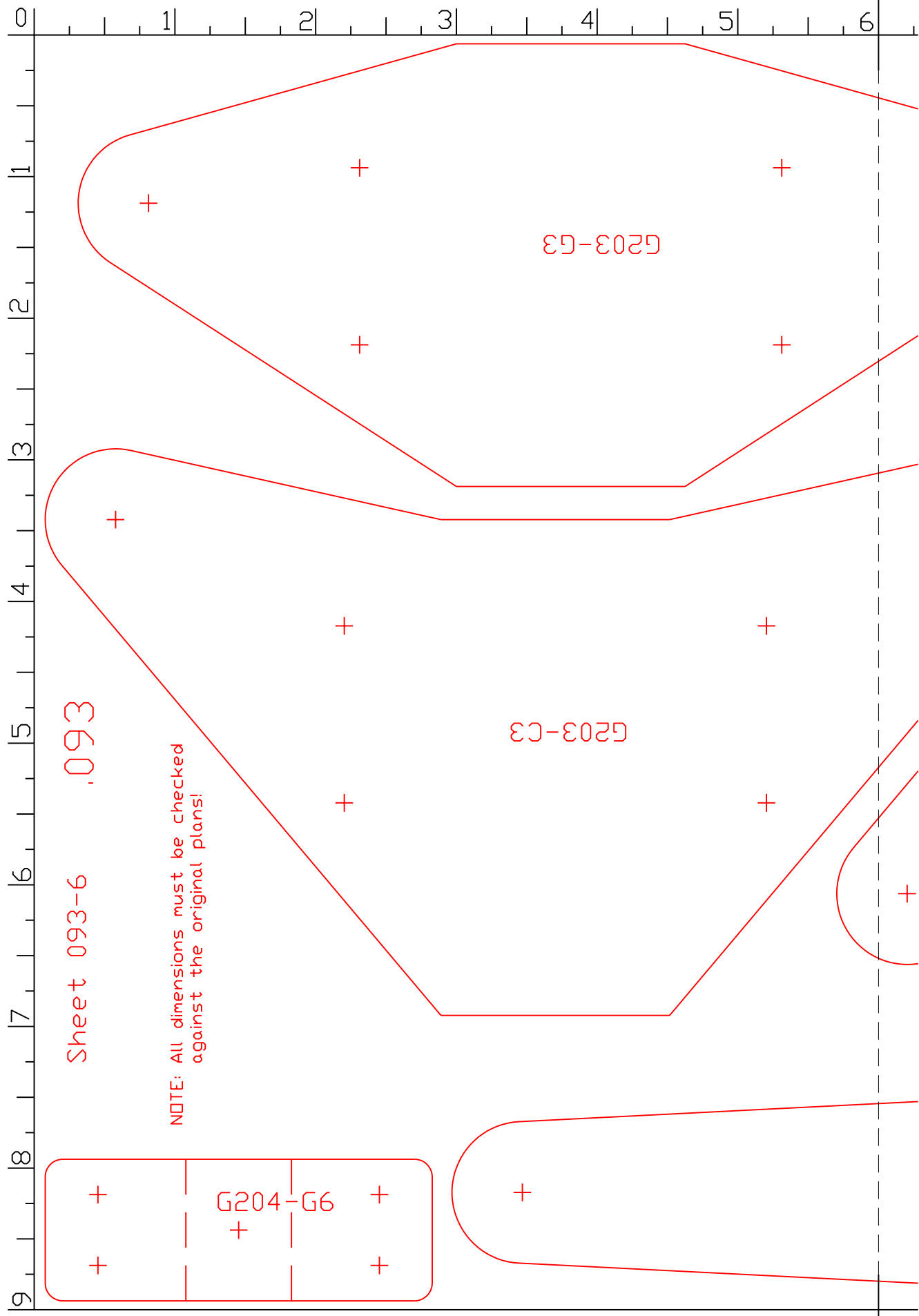

6 7 8 9 10 11 12

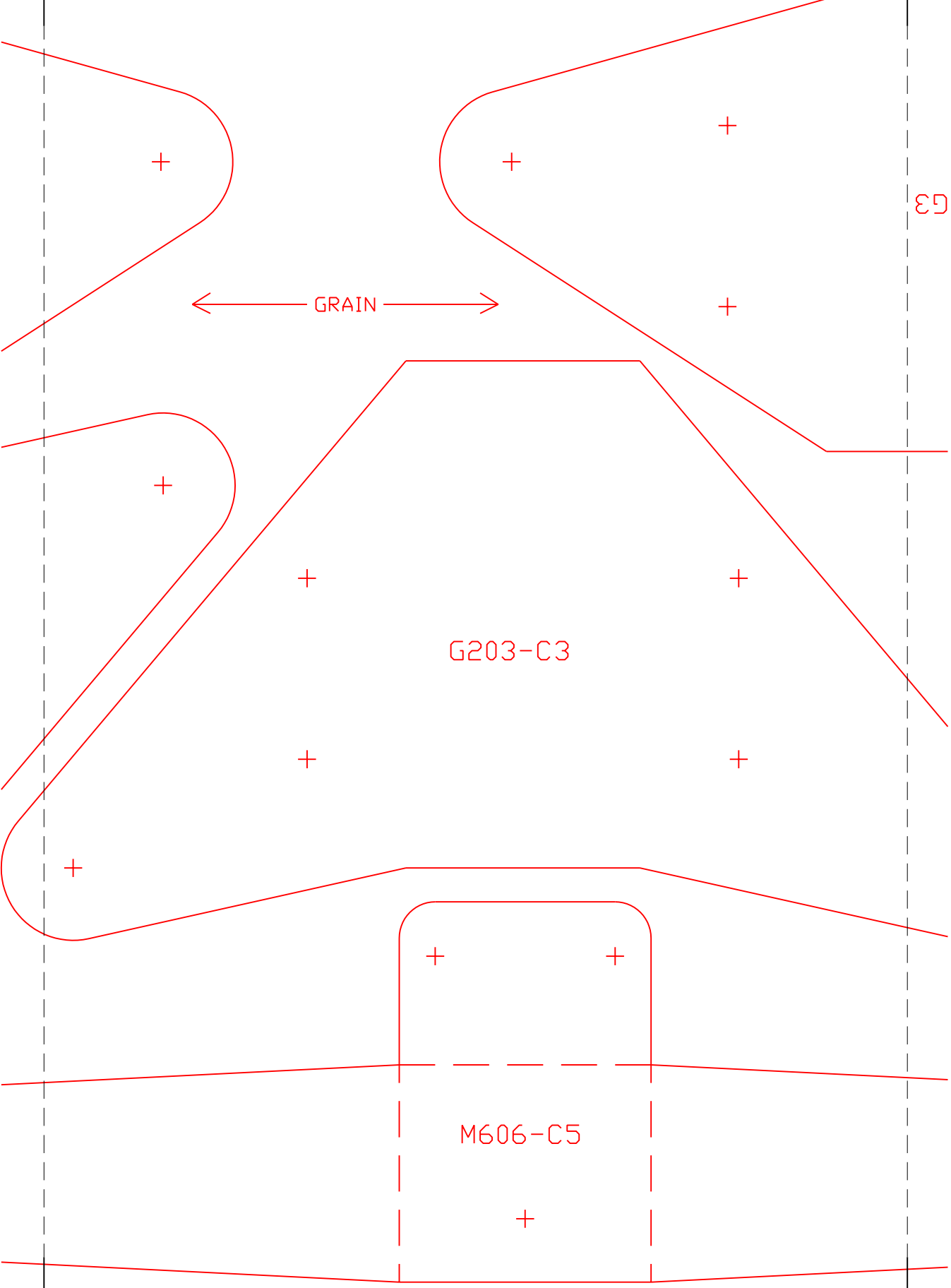

← GRAIN →

G203-C3

M606-C5

ε

12 13 14 15 16 17 18

G203-G3

G202-C6-B

M802-B8-R

Note 1

NOTE 1: Bend line not specified in plans!

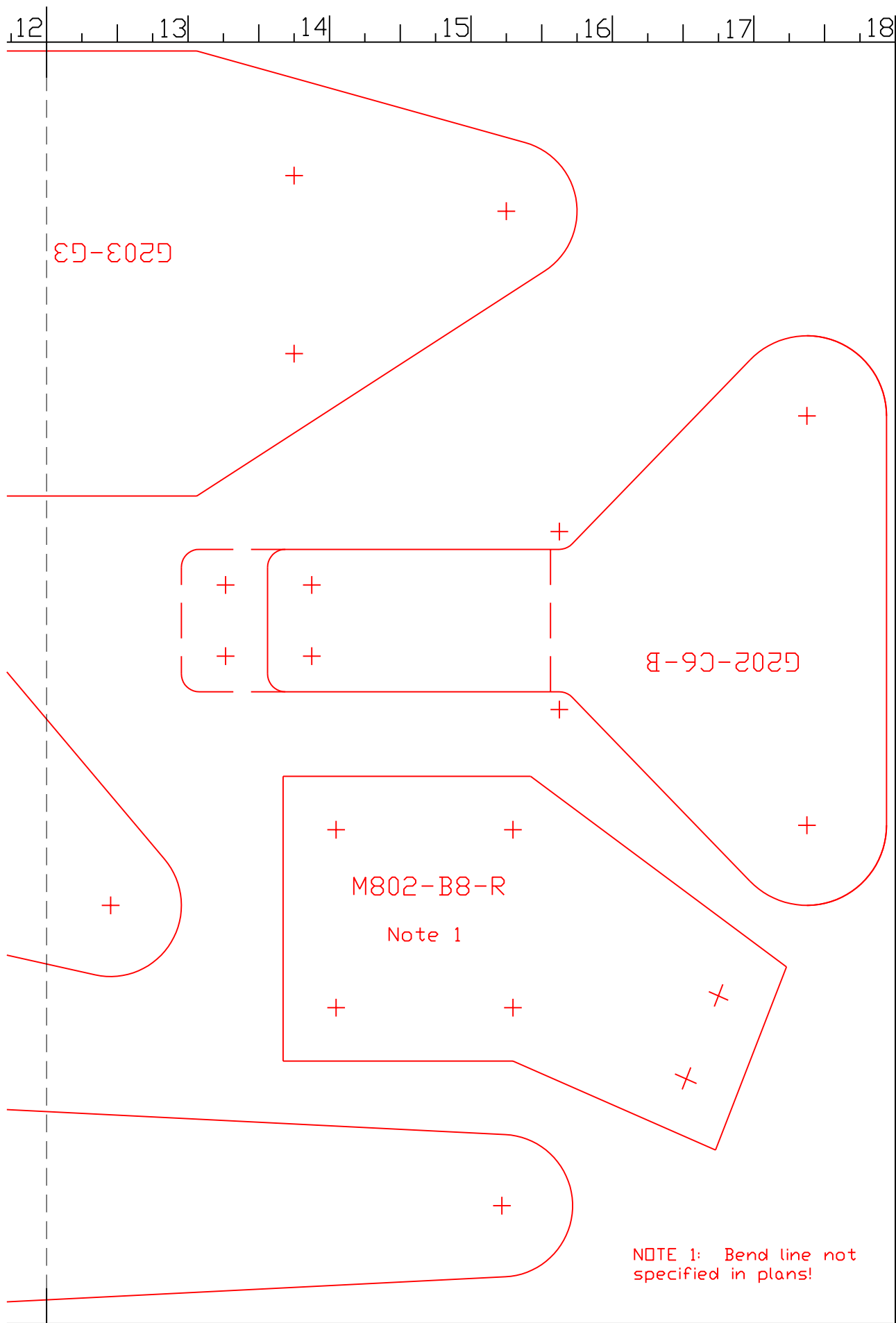

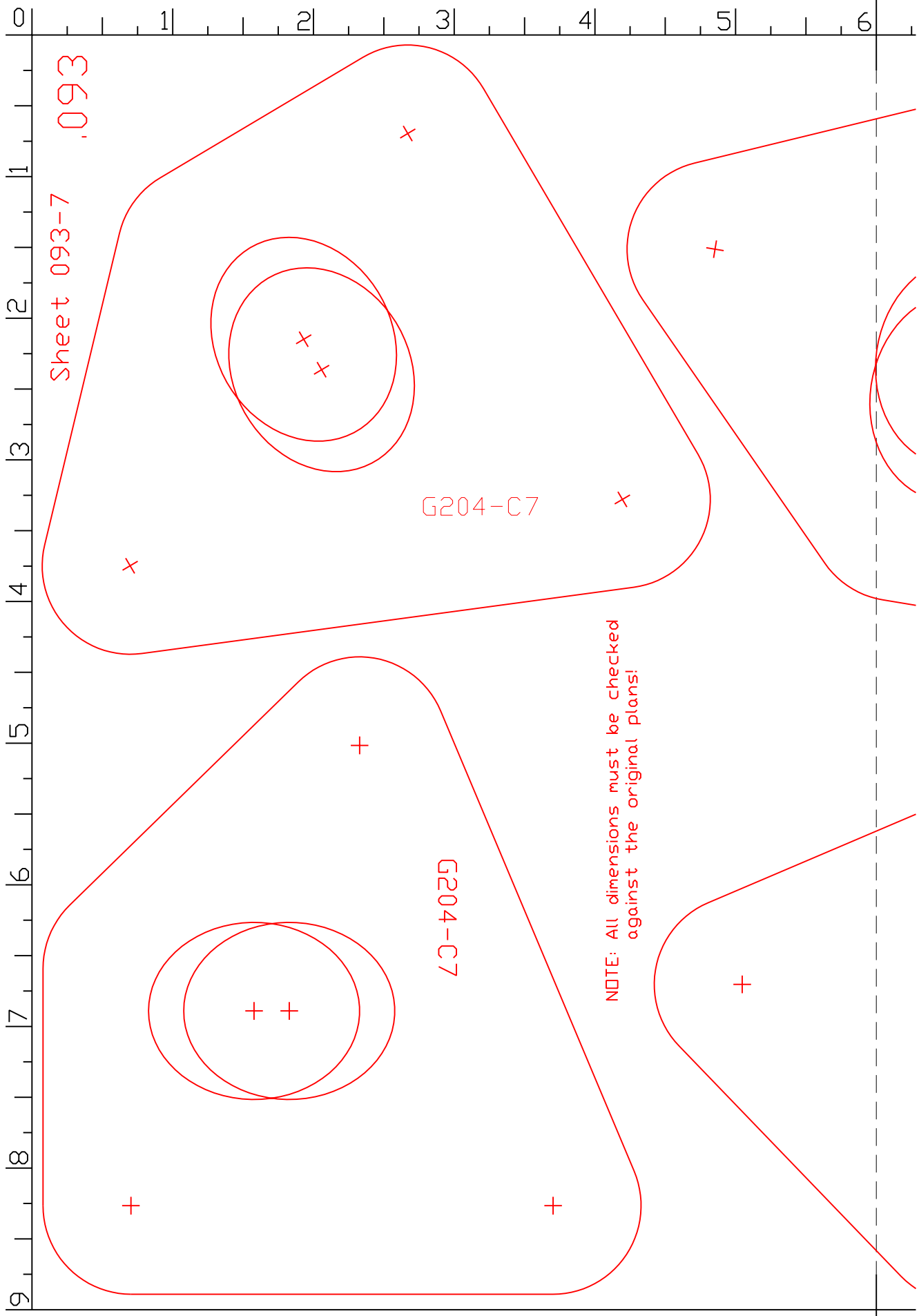

Sheet 093-7 .093

G204-C7

G204-C7

NOTE: All dimensions must be checked against the original plans!

Sheet 093-7

6 7 8 9

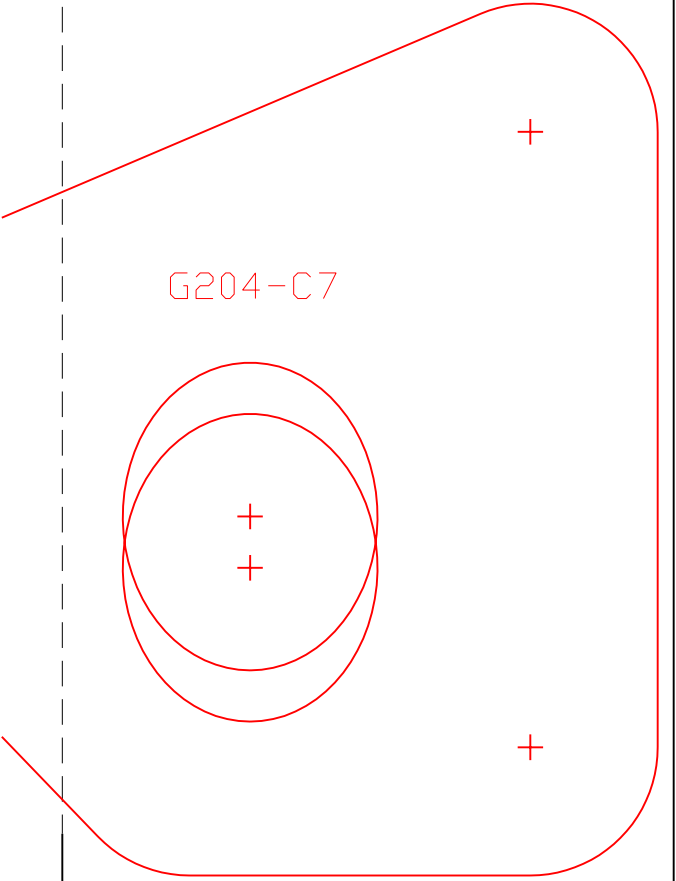
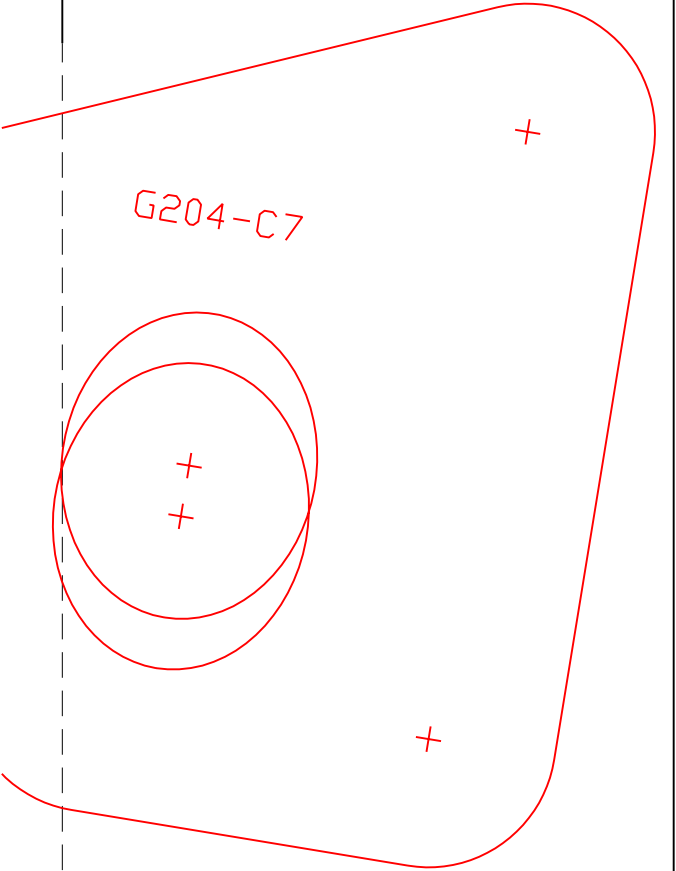

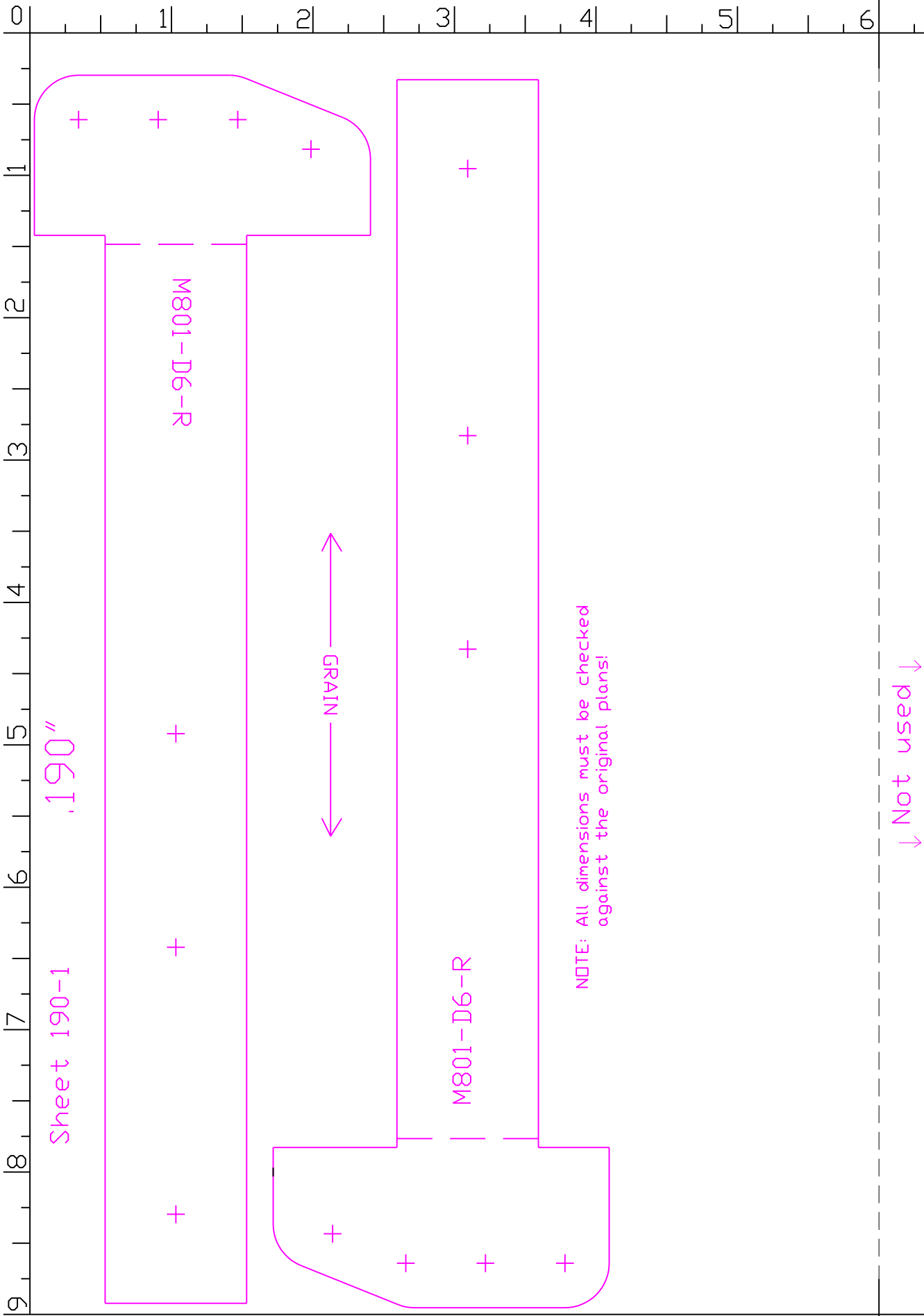

Sheet 190-1

M801-D6-R

M801-D6-R

GRAIN

NOTE: All dimensions must be checked against the original plans!

↓ Not used ↓

Sheet 190-1

Use 1 1/4" x 18"
Strip

